



COCOON

Boutique Bathrooms



COCOON

WWW.BYCOCOON.COM

INDEX

10	The COCOON Standards
20	John Pawson
25	John Pawson - Brushed Inox
28	John Pawson - Brushed Gold
32	John Pawson - Dark Grey
36	John Pawson - Natural Stone bath & basins
42	Piet Boon
46	Piet Boon - Brushed Inox
52	Piet Boon - Raw Copper
60	Piet Boon - Gun Metal Black
68	Piet Boon - Natural Stone and Solid Surface bath, basins & vanity
80	Cocoon Lab
82	Mono Collection
88	Solid Surface baths & basins



WE ARE COCOON

We believe in future classics, not temporary whims. Therefore, our designers also take the next generations into account. By always trying to use sustainable materials, our products will even make the difference after decades of use.

Our products are designed to make people happy, bring comfort and embrace personal identity. The idea is so pure that "COCOONING" is a true lifestyle. Nowadays, people have more need to be able to escape from the hectic and fast world we are living in and that is why home really should feel like home. A safe and warm place. A place where you come to rest, but also get inspired. A space for Transformation. A COCOON...





TEAM UP WITH COCOON

Our project division consist of an international & dedicated team of COCOON educated architects and project managers. We can assist in project design, quotations and the production of customised products to turn the most creative plans into reality.

Throughout the years COCOON has proven to be the ideal partner for developments of (urban) villas, hotels, yachts and wellness resorts.

Today COCOON holds a position of excellence with a reference list of hundreds of projects, implemented all over the five continents. The fresh and flexible approach and unsurpassed quality positioning (All taps are fully made of AISI 316L marine grade stainless steel) are the key values to accomplish a successful project.



The image features a background of marbled paper with soft, flowing patterns in shades of grey, white, and light brown. A thin black circle is centered on the page, containing the text "INSPIRED BY DREAMS" in a bold, black, sans-serif font. The text is arranged in two lines, with "INSPIRED" on the top line and "BY DREAMS" on the bottom line.

**INSPIRED
BY DREAMS**



SALINAS BATH - PEBBLE / PB SET24THERM - GOLD

FROM ROOM TO COCOON

Whether you are architect, interior designer or builder. Tell us your plans and we will help you to realise them. We will set you up with a professional account and send you all info you need to easily make comprehensive quotations for your clients and order fast and safely while enjoying professional rates.

We will ensure that your project will really stand out and will save you a lot of time, thoughts and money in the end. Get in touch with us, we are happy to help you!

THE COCOON STANDARDS

100% RECYCLABLE

The 316L stainless steel we use for our bathroom taps is 100% recyclable. When a product made of this special material finally reaches the end of its long service life, it remains a valuable source of its main alloying elements chromium, nickel and molybdenum. These can be easily recovered and returned to the production process. Stainless steel recycling is an economically viable, self-sustaining process.

ECO FRIENDLY PRODUCTS

Selected for their durability and quality, the materials we use for our taps, basins and baths, guarantee a long life span and are Eco-friendly. Not only because the material itself is recyclable and lead-free, but also because we use special water saving techniques to keep the carbon footprint as small as possible.

WATER SAVING

COCOON taps and showers can be ordered with a flow-limiting aerator, reducing water consumption without compromising experience. The result: a satisfying, voluminous flow that never exceeds 5 litres per minute, which is as kind to your pocket as it is to the environment. Using less water means less energy is required

to heat the water consumption, installing a COCOON bathroom tap will help reduce your energy bills too.

LOW ENVIRONMENTAL IMPACT

COCOON is proud to only use cold working methods for our stainless steel and solid surface material and does not influence global warming. The energy that powers the production is certified clean, water is saved and waste is separated to be recycled, to reduce the impact of the company on the ecosystem.

LEAD FREE TAPS

COCOON cares for you and for the world. The internal and exposed parts are made of 316L stainless steel and are by nature LEAD FREE. For projects in California and Vermont where special requirements of the California Health and Safety Code (commonly known as AB 1953) and Vermont Act 193 concerning lead in potable water systems apply, COCOON can deliver 100% stainless steel build-in valves for the wall mounted basin mixers, to be fully compliant to these standards.

CERTIFICATIONS

COCOON became an important reference within the sector for sustainable design and production. The components of our stainless steel tap collections, which are machined by high-tech equipment, are certified for their performance and safety by the most renowned Certifying institutes in the world.

ADVANCED COCOON BOX INSTALLATION SYSTEM

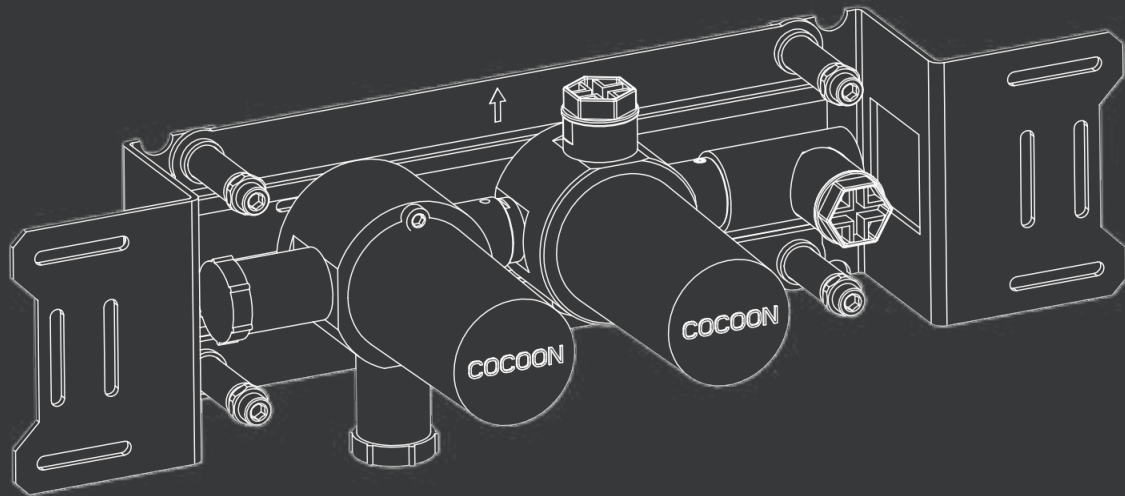

New revolutionary build-in system for John Pawson and Piet Boon tap ware collections.

The new system has some features which will enhance the ease of installation dramatically;

- depth adjustable installation frames for super easy and accurate installation
- lead free
- made in the highest grade AISI 316 stainless steel, in compliance with all major certifications
- all components on one frame, for fast installation
- ceramic cartridges are always reachable from the outside when walls are closed
- possibility to change exterior parts and thus the colors even after years of use
- optional NPT outlets for USA plumbing system



**RAW MATERIALS
THAT GET
MORE BEAUTIFUL
WITH AGE**



COCOON and Studio Piet Boon share passion for craftsmanship, timeless design and natural materials that beautify with age. This mutual passion is captured in an exclusive collection of contemporary taps & basins:

Shape by Studio Piet Boon.

Shape by Studio Piet Boon brings industrial chic to any kitchen or bathroom.





Photo by Thomas De Bruyne

GEOMETRIC SHAPES CLEAR TO OPERATE

Inspired by the simplicity and symmetry of geometric shapes, the tap collection consists of an unconventional shaped faucet and soft clear contoured mixer that comprises of two isolated components, intuitively instructing how to be operated.

The bath & vanity collection is available in sustainable materials such as solid surface, natural stone and wood.

A black and white photograph of sand dunes with a white circle overlaid in the center containing text.

SIMPLICITY IS
THE ULTIMATE
SOPHISTICATION

LEONARDO DA VINCI





HANDCRAFTED QUALITY WITH SOUL

Making timeless and sturdy design is only one side of the coin. By using real sustainable materials and having the right people shaping these into pieces of usable art, our products are engineered to last a lifetime.

In Italy near the idyllic Lago Maggiore, true craftsmen shape our taps and showers from noble stainless steel by hand and machine.

New ideas from our designers offer a fresh look on tried and tested artisanal skills to make unique products according to traditional production values.



PB COLUMN - CARRARA SUPREME

Photo by Thomas De Bruyne

The production of our baths and made-to-measure basins takes place in our advanced workshop in the Netherlands.

We definitely believe that the decades of combined experience will reflect in every single product we make.



JOHN PAWSON

British architect

British architect John Pawson CBE, who founded his firm of the same name in 1981, is often hailed as the father of modern architectural minimalism. Although a title he would most likely poke fun at, for almost forty years Pawson has championed nothingness as the most straightforward form of beauty.

During his lustrous career, ***simplicity as a philosophy*** is something he has explored in retail designs for Jil Sander, Calvin Klein, Christofer Kane and in various monasteries, churches, musea, residential projects, hotels and now a complete contemporary bathroom collection for COCOON.





JP COLUMN - NATURAL SAND



JOHN PAWSON FOR COCOON

John Pawson designed a complete range of bathroom and kitchen tap ware in the COCOON signature material AISI316 marine grade stainless steel and a collection of bathtubs, bespoke basins and vanity made from natural stone.



JP COLUMN - GRIGGIO EMPERADOR

Using pure and geometrical shapes, always honoring the 'golden ratio', John Pawson created another **timeless concept which will be enjoyed for many years to come.**

The gracious perfect shapes and spouts with extremely large radiuses are typical for his timeless faucet and shower collection.



JOHN PAWSON
BRUSHED INOX
TAP WARE COLLECTION



John Pawson designed a complete range of bespoke bathroom and kitchen tap ware in the COCOON signature material AISI316 marine grade stainless steel.





BRUSHED INOX is the purest finishing as it embraces the solid simplicity of the product. Just solid stainless steel with its brushed raw but clean character, treated with NANO anti fingerprint coating.



JOHN PAWSON
BRUSHED GOLD
TAP WARE COLLECTION





The gracious perfect round shapes and spouts with extremely large radiuses are distinctive features. Our BRUSHED GOLD finishing just gives that extra dimension. We applied an anti fingerprint coating utilizing the latest NANO technology.



JP SET23THERM.2 - GOLD



JP 30 - GOLD



JOHN PAWSON

DARK GREY

TAP WARE COLLECTION





JP SET01.1 - DARK GREY

The John Pawson by COCOON collection is available in 3 unique PVD colors especially made for COCOON, all applied on the everlasting brushed steel and packed with new technological features as NANO anti fingerprint coating, the latest water saving systems and a fully adjustable build-in system to for easy installation.



JP SET24THERM.2 - DARK GREY



JP 16 - DARK GREY

DARK GREY is a new colour especially engineered for this collection
by COCOON.

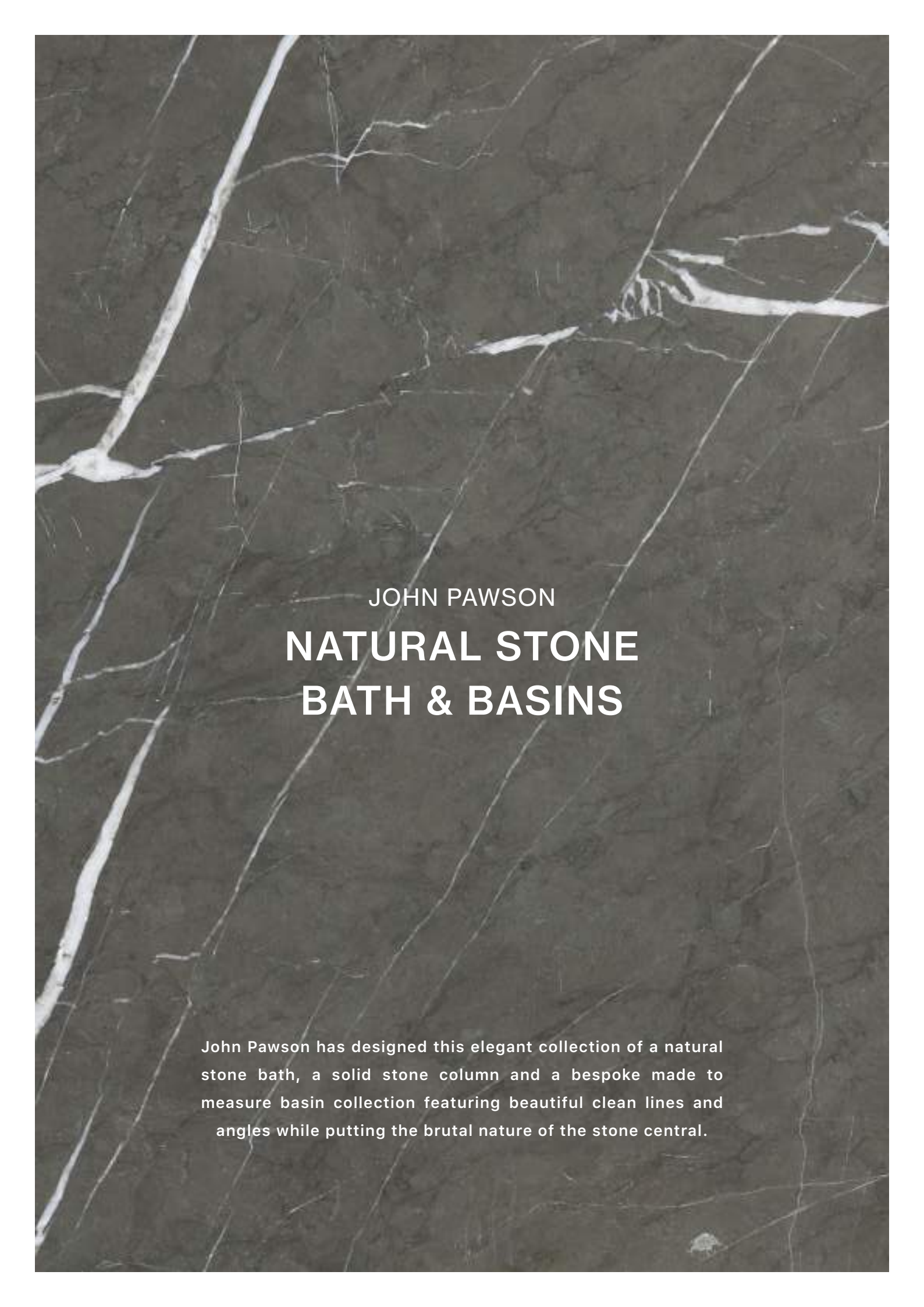

JOHN PAWSON
**NATURAL STONE
BATH & BASINS**

John Pawson has designed this elegant collection of a natural stone bath, a solid stone column and a bespoke made to measure basin collection featuring beautiful clean lines and angles while putting the brutal nature of the stone central.





JP BATH - CARRARA SUPREME

Each object is a piece of art, a living legend. The timeless John Pawson signature design has finally been captured in an exclusive yet approachable bathroom collection. The solid blocks of marble have been meticulously selected from the famous stone quarries in Italy and crafted to perfection into items to be melted seamlessly in their surroundings, as if they were always there.



JP BATH - PIETRA GRIGGIO / JP SET25THERM.2 - GOLD





JP BATH - NATURAL SAND



PIET BOON

Designer

Cocoon has the pleasure of working with Studio Piet Boon, one of the most renowned Dutch design studios. Studio Piet Boon creates bespoke contemporary architecture, interiors and product designs. Recognised worldwide for its exceptional craftsmanship, quality and vision, Studio Piet Boon creates distinguished design.

Founded in 1983 by Dutch designer Piet Boon (1958), the Studio Piet Boon philosophy is based on a balance between functionality, aesthetics and individuality. The ingredients that define the Piet Boon and COCOON experience. Suitable for every discipline, applicable to any industry.







PB 37 OUTDOOR SHOWER - COPPER

Photo by Thomas De Bruyne



PB BASIN 60/90 L - PIETRA GRIGGIO / PB SET11 - COPPER

Photo by Thomas De Bruyne



PIET BOON
BRUSHED INOX
TAP WARE COLLECTION





Make the difference after decades of use

Stainless steel offers many advantages to the architectural and high demanding user, including its high corrosion resistance and durability.



PB SET01



PB 01



PB BASIN 60/12 - NATURAL GREY (BRUSHED)

Photo by Thomas De Bruyne

The aesthetic appearance of this ECO friendly and LEAD FREE material provides a modern and attractive base for our minimalistic tap collection designed by Piet Boon. Available in brushed stainless steel, and the exclusive "Raw Copper" and "Gunmetal Black" finishings.





PB BATH - NATURAL LIGHT GREY / PB SET25THERM



PIET BOON

RAW COPPER

TAP WARE COLLECTION



When water meets fire

Add some refined sophistication to your bathroom
with our new Raw Copper taps.





PB SET11 - COPPER



PB 04 - COPPER



Different from what is common in the market, the exclusive finishings by COCOON are applied on a 100% stainless steel base instead of a coating on brass. Due to patented PVD processes, our finishing is merged with the stainless steel surface retaining and even increasing all of the sustainable and durable properties COCOON taps are known for.



PB SET01 - COPPER



PB 30 - COPPER





PB SET21 - COPPER



PIET BOON
GUN METAL BLACK
TAP WARE COLLECTION



PB SET37 OUT DOOR SHOWER - BLACK

Exclusive finishings by COCOON

The industrial chic "Gunmetal Black" combines perfectly with our COCOON solid white baths and basins.



PB SET01- BLACK

The characteristic appearance of the hand brushed stainless steel enriches the experience of the exclusive finishings, adding depth and soul to the surfaces.



PB 30 - BLACK



Photo by Thomas De Bruyne





PB SET01 - BLACK / PB BASIN 60/20 B - NERO MARQUINA

Photo by Thomas De Bruyne



PB SET24 - BLACK



Photo by Thomas De Bruyne



PB SET01 - BLACK



PB 03

PIET BOON

**NATURAL STONE AND
SOLID SURFACE BATH,
BASINS & VANITY**

This new comprehensive bathroom system is meant to embrace a wide range of sizes and material combinations. Available in the signature understated Piet Boon color and material palettes, the items can be assembled according to personal taste and budget.



Emphasizing the experience, the collection seamlessly blends with other Piet Boon products.

Centerpiece of the collection is the natural stone bathtub with a basin column. Carved from a single block of natural marble it is the absolute summum.







The basins are made from natural stone or solid surface while the cabinets can have fronts of wood but are also available in the same finishings as the basins.



PB BASIN 60/40 R - CARRARA SUPREME / CABINET 60/40 - GREY



PB BASIN 60/40 R - NATURAL BEIGE / CABINET 60/40 - SMOKE



PB BASIN 40/40 R - NATURAL LIGHT GREY

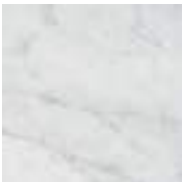

CARRARA
SUPREME



COCOON
BIANCO



GRIGGIO
AMSTERDAM



GRIGGIO
EMPERADOR



NATURAL
BEIGE



NATURAL
GREY



NATURAL
LIGHT GREY



NATURAL
SAND



NERO
MARQUINA



PIETRA
GRIGGIO



PB BATH - NATURAL LIGHT GREY



PB BASIN 120/20 - NATURAL SAND / CABINET 120/20 - SMOKE



WHITE



SMOKE



SHADOW

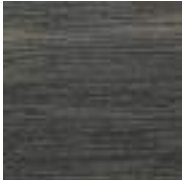

GREY



DARK CLAY



PB BASIN 40/40 R -CARRARA SUPREME



MADE
TO LAST
A LIFETIME



COCOON LAB



Our in-house design department has concocted a complete range of items ideally engineered for the hospitality sector and larger project investments in which budget and quality are the two main focus points. Indestructible quality and the timeless design COCOON has been known for at a reasonable price. COCOON is for everyone.



ATLANTIS BATH - CHALK WHITE

A photograph of a modern shower fixture mounted on a light-colored wall. The fixture consists of two circular knobs on the left and a handheld showerhead on the right, connected by a long, flexible metal hose that forms a large loop. The showerhead is a sleek, cylindrical design. The background is a plain, light-colored wall. In the bottom left corner, a portion of a wooden stool is visible.

**MONO COLLECTION
& BATHROOM
ACCESSORIES**



FREEDOM OF CREATION

Timeless minimalistic approach to design tap ware made the MONO Collection by COCOON famous. By its modular nature and stripped back design to essential beauty and golden ratios, this collection has been the weapon of choice for a great amount of leading architects from all over the world since many years.

Crafted from indestructible AISI 316L marine grade stainless steel, the MONO collection is one of the most versatile and sustainable collections out there.





MONO SET24



MONO 01THERM





MONO SET01



CUSTOM 50 - CHALK WHITE



**SOLID SURFACE
BATHS & BASINS**



ATLANTIS BATH - EARTH

COCOON baths and basins are casted from solid surface in our workshop in the Netherlands. Solid surface is a strong durable material with a stone-like appearance. Unlike stone, solid surface is non-porous. Making it easy to clean and resistant to stains, moisture and sunlight. This makes solid surface ideal for the bathroom environment.

Being a homogenous surface it is solid throughout. While being virtually scratch-proof, if it does become scratched after years of use it can easily be refinished. Our successful made-to-measure SOLID collection is available in 6 different colours.

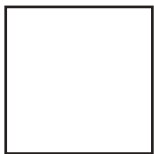

CHALK

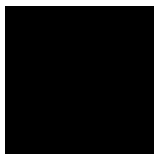

COAL



DUST



EARTH



PEBBLE



ANTHRACITE







ATLANTIS BATH - COAL

Photo by Thomas De Bruyne



PB BASIN 60/90 R - PEBBLE

Photo by Thomas De Bruyne









COCOON

AMSTERDAM - ATHENS - BARCELONA - BELGIUM - NEW YORK
BEVERLY HILLS - CAPE TOWN - GERMANY - IBIZA - LONDON - MEXICO
PARIS - SHANGHAI - KUALA LUMPUR - SAN FRANCISCO

WWW.BYCOCOON.COM

+31 20 808 7557 / INFO@BYCOCOON.COM