

Marcel

design A. Parisio - G. Pezzano

cielo

handmade in Italy

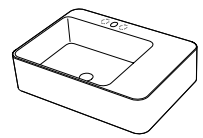

LAVABO / WASHBASIN

CERAMICA / CERAMIC



+

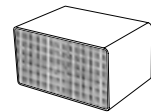

CASSETTO / DRAWER

ESSENZA / WOOD



FRONTALE / FRONTAL

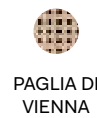

+

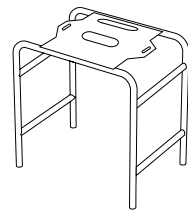

STRUTTURA / FRAMEWORK

ESSENZA / WOOD



FRONTALE / FRONTAL

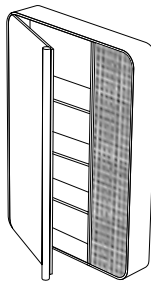
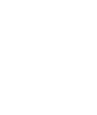

SPECCHIO / MIRROR

ESSENZA / WOOD





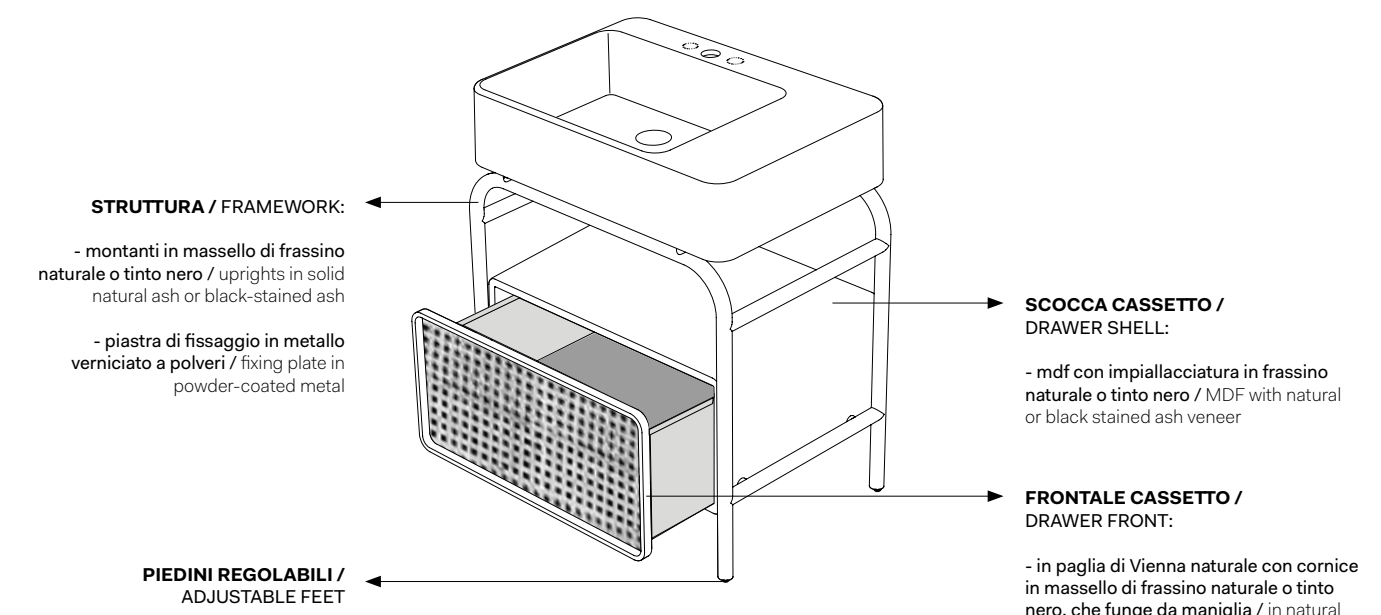
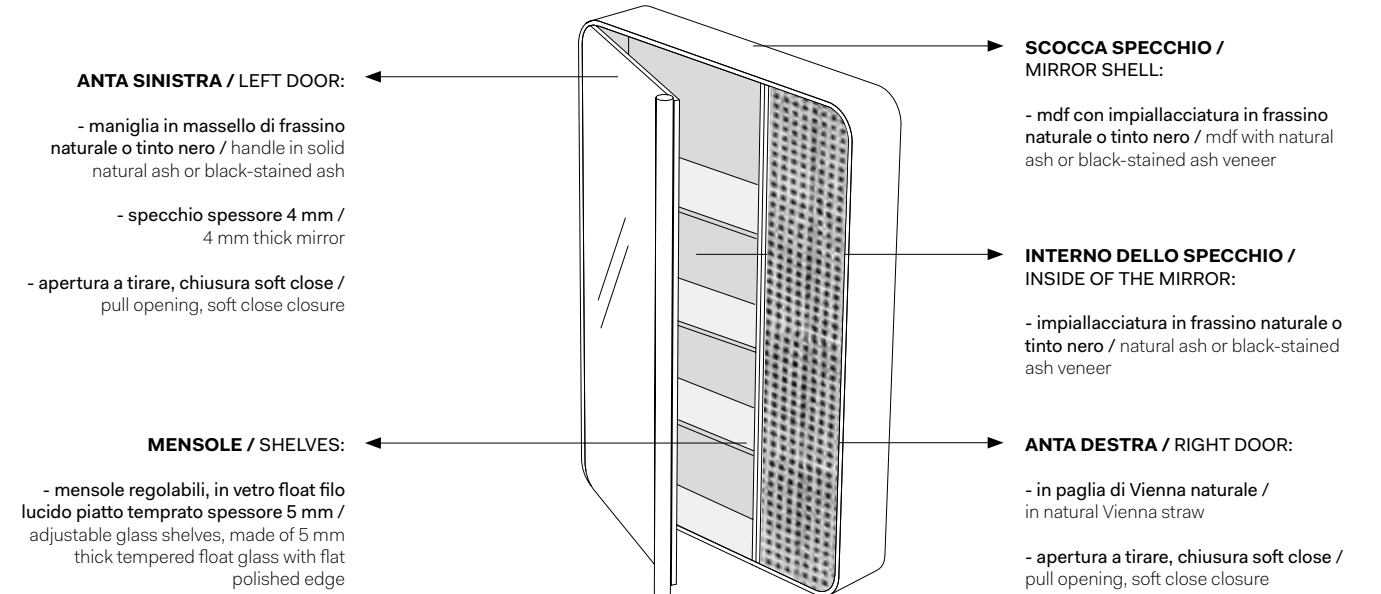





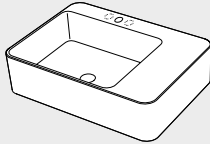

FRONTALE / FRONTAL

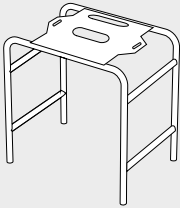

MARCEL

mobile con lavabo / cabinet with washbasin: cm 72 x 50 x 87 h

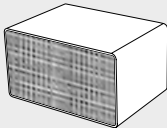
specchio / mirror: cm 68 x 13 x 100 h

<h1>Marcel</h1> <p>You can order it from June 1st 2022 disponible a partir del 1 de Junio de 2022 \ Vous pouvez le commander à partir du 1er Juin 2022 \ доступно для заказа с 1 Июнь 2022</p>	Size (cm) Medidas Dimensions Maße Размеры	Product code Artículo Article Artikel Артикул	Net weight(Kg) Peso neto Poids net Reingewicht вес нетто	Finishes Acabados Finitions Farbe Отделки	
 <p>Ceramic washbasin with 1 hole Lavabo de cerámica monoagujero \ Lavabo en céramique avec un trou \ Waschbecken aus Keramik mit 1 Hahnloch \ Керамическая раковина на одно отверстие</p> 	72 x 50 x h17	MALA(X)* MALASF(X)* no tap hole sin agujero sans orifice ohne Loch без отверстия	27,00	 Glossy White  Le Terre di Cielo  Le Acque di Cielo	
<p>For on top installation customers are advised to the require the "RETTIFICA" option Para instalaciones de apoyo se aconseja usar la opción "RETTIFICA" / Pour l'installation à poser on conseille l'option "RETTIFICA" / Bei Aufsatzmontage bitte die Option "RETTIFICA" anfragen / При установке на столешницу рекомендуется запросить опцию "RETTIFICA"</p>		RETTIFICA GRINDING			
 <p>Structure in natural or black stained solid Ash wood Estructura de fresno macizo natural o teñido de negro / Structure en bois massif de frêne naturel ou teinté noir / Struktur aus Massivholz Esche natur oder schwarz lackiert / Структура из массива ясеня в отделке натуральный или крашеный в черный цвет</p> <p> framework mandatory with washbasin and drawer estructura obligatoria con lavabo y cajón structure obligatoire avec évier et tiroir obligatorische Struktur mit Spüle und Schublade обязательная конструкция с раковиной и ящиком</p>	72 x 50 x h70	MASTE(X)*	23,00	 NA - Frassino tinto naturale  NM - Frassino tinto nero	
 <p>Drawer in natural or black stained Ash wood, with the front in natural Vienna straw Cajón de fresno natural o teñido de negro, con frente de paja de Viena natural / Tiroir en frêne naturel ou teinté noir, avec façade en paille de Vienne naturelle / Schublade aus Eschenholz natur oder schwarz lackiert, mit Frontblende / Ящик из ясеня в отделке натуральный или крашеный в черный цвет. Фасад из венской соломы в отделке натуральная</p>	65 x 50 x h33	MACE(X)*	8,00	 NA - Frassino tinto naturale  NM - Frassino tinto nero	

Le Terre di Cielo	 TL - Talco	 PM - Pomice	 BR - Brina	 BA - Basalto	 LV - Lavagna	 CM - Cemento	 FN - Fango	 CA - Cacao
	 AN - Arenaria	 AV - Avena	 LN - Lino	 AG - Agave	 MU - Muschio	 PL - Polvere	 CP - Cipria	 CN - Canapa
Le Acque di Cielo	 OL - Oltremare	 SM - Smeraldo	 AL - Alga	 CO - Corallo	 NI - Ninfea	 AM - Anemone		

Marcel art. MALA

lavabo in ceramica monoforo
ceramic washbasin with one hole

cielo

handmade in Italy

PESO NETTO/NET WEIGHT: 27,00 Kg



NOTE/NOTES

Lavabo in ceramica. Disponibile nell'opzione senza foro rubinetto (art. MALASF).

Washbasin made of ceramic. Available the option without tap hole (art. MALASF)



DoP No. 14688.01

ACCESSORI/ACCESSORIES:

PIL01 - Piletta universale click-clack CROMO con coperchio in ceramica / Universal click-clak drain in CHROME with ceramic lid

PIL01NM - Piletta universale click-clack NERO MATT con coperchio in ceramica / Universal click-clak drain in MATT BLACK with ceramic lid

PIL01BR - Piletta universale click-clack BRONZO con coperchio in ceramica / Universal click-clak drain in BRONZE with ceramic lid

PIL01CM - Piletta universale click-clack CEMENTO con coperchio in ceramica / Universal click-clak drain in CEMENTO with ceramic lid

SISP - Sifone CROMO / CHROME siphon

SIFN - Sifone NERO MATT / MATT BLACK siphon

SIFBR - Sifone BRONZO / BRONZE siphon

SIFCM - Sifone CEMENTO / CEMENTO siphon

FINITURE LAVABO
WASHBASIN FINISHES

○ Bianco/white - glossy

Le Terre di Cielo

- Talco
- Pomice
- Brina
- Basalto
- Lavagna
- Cemento
- Fango
- Cacao
- Arenaria
- Avena
- Lino
- Agave
- Muschio
- Polvere
- Cipria
- Canapa

Le Acque di Cielo

- Oltremare
- Smeraldo
- Alga
- Corallo
- Ninfea
- Anemone

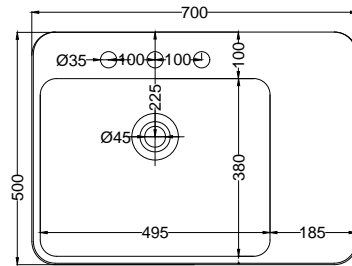

TOP

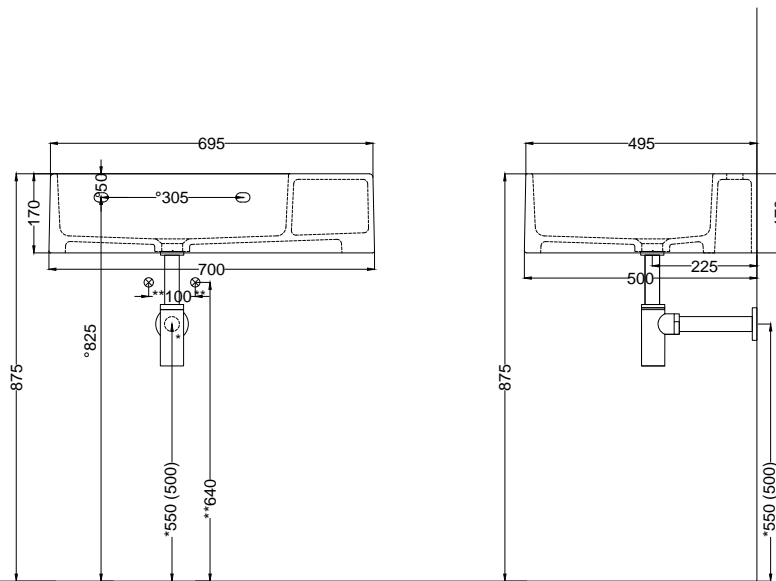

* WATER OUTLET WITH SISP/SIFN/SIFBR/SIFCM
** WATER INLET (HOT-COLD)
* WALL FIXINGS

SIDE

ATTENZIONE:

Superfici, pesi e misure riportate possono presentare leggere differenze rispetto ai pezzi reali, in considerazione e accordo delle caratteristiche di tolleranza intrinseche del materiale ceramico e del suo processo produttivo. L'azienda si riserva di cambiare schede tecniche e caratteristiche di funzionamento degli articoli in ogni momento e senza necessità di preavviso.

ATTENTION:

Surfaces, weights and dimensions can show some little differences compared to the real item, following typical intrinsic characteristics of ceramics material and production. The company reserves the right to change any technical specifications/dimension and/or operating characteristics of the products at any time and without giving notice.

Marcel art. MALA-MASTE-MACE

lavabo Marcel con struttura e cassetto
Marcel washbasin with drawer

cielo
 handmade in Italy



PESO NETTO/NET WEIGHT: 27,00Kg
(lavabo/washbasin) + 23,00 Kg
(struttura/framework) + 8,00 Kg
(cassetto/drawer)

ACCESSORI/ACCESSORIES:

PIL01 - Piletta universale click-clack CROMO con coperchio in ceramica / *Universal click-clack drain in CHROME with ceramic lid*

PIL01NM - Piletta universale click-clack NERO MATT con coperchio in ceramica / *Universal click-clack drain in MATT BLACK with ceramic lid*

PIL01BR - Piletta universale click-clack BRONZO con coperchio in ceramica / *Universal click-clack drain in BRONZE with ceramic lid*

PIL01CM - Piletta universale click-clack CEMENTO con coperchio in ceramica / *Universal click-clack drain in CEMENTO with ceramic lid*

SISP - Sifone CROMO / *CHROME siphon*

SIFN - Sifone NERO MATT / *MATT BLACK siphon*

SIFBR - Sifone BRONZO / *BRONZE siphon*

SIFCM - Sifone CEMENTO / *CEMENTO siphon*

NOTE/NOTES

Lavabo in ceramica; Cassetto in legno; Struttura in legno. Disponibile nell'opzione senza foro rubinetto (art. MALASF).

Washbasin made of ceramic; Drawer made of wood; Framework made of wood or coated steel. Available the option without tap hole (art. MALASF)



DoP No. 14688.01

FINITURE LAVABO

WASHBASIN FINISHES

Gloss White

Le Terre di Cielo

- | | |
|-----------|------------|
| ● Talco | ● Arenaria |
| ● Pomice | ● Avena |
| ● Brina | ● Lino |
| ● Basalto | ● Agave |
| ● Lavagna | ● Muschio |
| ● Cemento | ● Polvere |
| ● Fango | ● Cipria |
| ● Cacao | ● Canapa |

FINITURE DEL CASSETTO

BOTTOM DRAWER FINISHES

legno/wood

● Frassino tinto naturale

● Frassino tinto nero

+

● frontale in paglia di Vienna naturale

FINITURE STRUTTURA IN LEGNO

WOODEN FRAMEWORK FINISHES

legno/wood





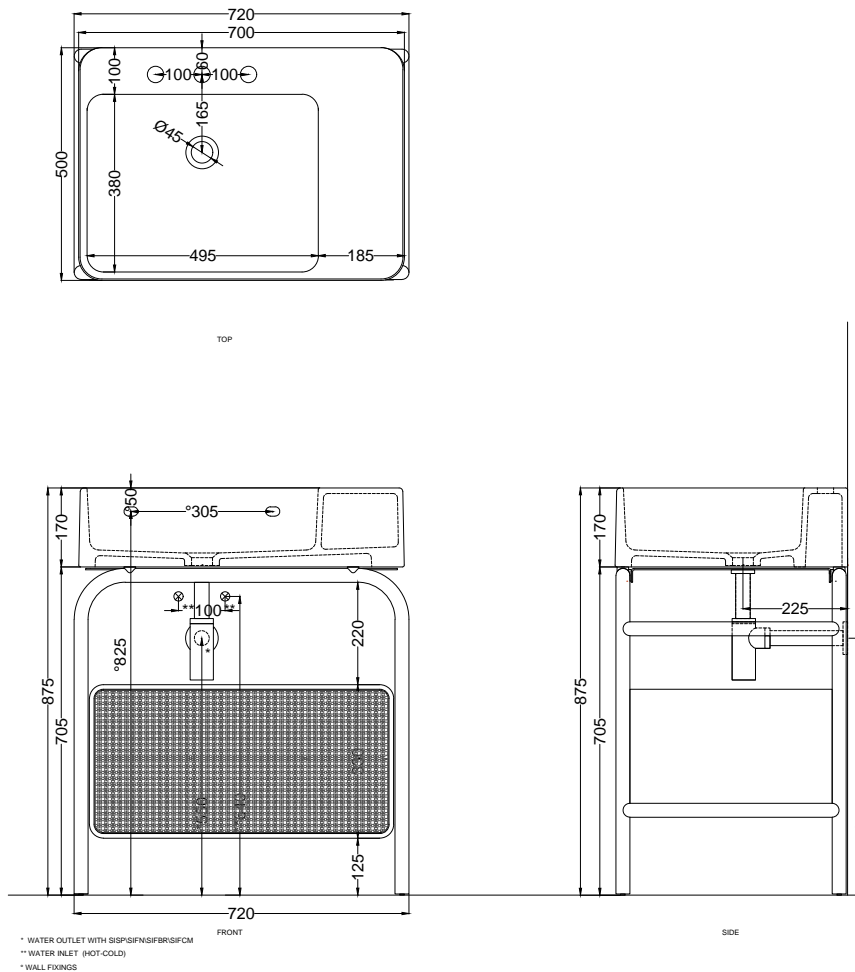

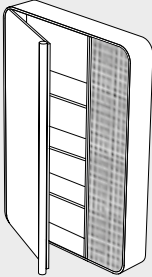

● Frassino tinto naturale

● Frassino tinto nero



ATTENZIONE:
 Superfici, pesi e misure riportate possono presentare leggere differenze rispetto ai pezzi reali, in considerazione e accordo delle caratteristiche di tolleranza intrinseche del materiale ceramico e del suo processo produttivo. L'azienda si riserva di cambiare schede tecniche e caratteristiche di funzionamento degli articoli in ogni momento e senza necessità di preavviso.

ATTENTION:
 Surfaces, weights and dimensions can show some little differences compared to the real item, following typical intrinsic characteristics of ceramics material and production. The company reserves the right to change any technical specifications/ dimension and/or operating characteristics of the products at any time and without giving notice.

<h1>Marcel</h1> <p>You can order it from June 1st 2022 disponible a partir del 1 de Junio de 2022 \ Vous pouvez le commander à partir du 1er Juin 2022 \ доступно для заказа с 1 Июнь 2022</p>	Size (cm) Medidas Dimensions Мәре Размеры	Product code Artículo Article Artikel Артикул	Net weight (Kg) Peso neto Poids net Reingewicht вес нетто	Finishes Acabados Finitions Farbe Отделки	
 <p>Rectangular mirror cabinet, with double door, with natural or black stained solid Ash wood frame and front right door in natural Vienna straw</p> <p>Espejo contenedor rectangular, con puerta doble, con borde en madera de fresno macizo natural o teñido de negro y puerta delantera derecha en paja de Viena natural / Miroir de rangement rectangulaire, à double porte, avec structure en de frêne naturel ou teinté noir et façade droite en paille de Vienne naturelle / Rechteckiger Spiegelschrank, mit Doppeltür, mit Korpus aus Esche natur oder schwarz lackiert, mit rechter Frontblende aus Wiener Geflecht natur / Прямоугольный зеркальный шкафчик, с двойной дверью. Корпус из ясеня в отделке натуральный и передней правой дверцей из венской соломы в отделке натуральная</p>	68 x 100 x 13	MASPRE(X)*	29,00	<ul style="list-style-type: none"> ● NA - Frassino naturale ● NM - Frassino tinto nero 	
 <p>Universal click/clack drain in CHROME with ceramic lid Válvula universal click/clack Cromado con tapa en cerámica \ Bonde universelle clic/clac Chromé avec clapet en céramique \ Universal-Abflussgarnitur Click-Clack Chrom mit Keramikstopfen \ Универсальный донный клапан click/clack хром с керамической крышкой</p>		PIL01(X)*	0,40	<ul style="list-style-type: none"> ● Gloss White ● Le Terre di Cielo ● Le Acque di Cielo 	
 <p>Universal click/clack drain in BLACK MATT finish with ceramic lid Válvula universal click/clack Negro Matt con tapa en cerámica \ Bonde universelle clic/clac Noir Matt avec clapet en céramique \ Universal-Abflussgarnitur Click-Clack Matt Schwarz mit Keramikstopfen \ Универсальный донный клапан click/clack черный матовый с керамической крышкой</p>		PIL01NM(X)*	0,40	<ul style="list-style-type: none"> ● Gloss White ● Le Terre di Cielo ● Le Acque di Cielo 	
 <p>Universal click/clack drain in CEMENTO finish with ceramic lid Válvula universal click/clack Cemento con tapa en cerámica \ Bonde universelle clic/clac Cemento avec clapet en céramique \ Universal-Abflussgarnitur Click-Clack Cement mit Keramikstopfen \ Универсальный донный клапан click/clack с керамической крышкой</p>		PIL01CM(X)*	0,40	<ul style="list-style-type: none"> ● Gloss White ● Le Terre di Cielo ● Le Acque di Cielo 	
 <p>Universal click/clack drain in BRONZE with ceramic lid Válvula universal click/clack Bronce con tapa en cerámica \ Bonde universelle clic/clac Bronze avec clapet en céramique \ Universal-Abflussgarnitur Click-Clack Bronze mit Keramikstopfen \ Универсальный донный клапан click/clack бронза с керамической крышкой</p>		PIL01BR(X)*	0,40	<ul style="list-style-type: none"> ● Gloss White ● Le Terre di Cielo ● Le Acque di Cielo 	
 <p>CHROMED siphon Sifone Cromado \ Siphon Chromé \ Siphon Verchromt \ сифон Chrome</p>		SISP	0,93	<ul style="list-style-type: none"> ● Chrome 	
 <p>MATT BLACK siphon Sifone Negro Mate \ Siphon Noir Mat \ Siphon Schwarz Matt \ Сифон Черный матовый</p>		SIFN	0,93	<ul style="list-style-type: none"> ● Matt Black 	
 <p>CEMENTO siphon Sifone Cemento \ Siphon Cemento \ Siphon Cemento \ сифон Cemento</p>		SIFCM	0,93	<ul style="list-style-type: none"> ● Cemento 	
 <p>BRONZE siphon Sifone Bronce \ Siphon Bronze \ Siphon Bronze \ бронза сифон</p>		SIFBR	0,93	<ul style="list-style-type: none"> ● Bronze 	

Technical symbols legend / Símbolos técnicos clave / Légende symboles techniques / Technische Zeichenerklärung / Перечень технических символов

 <p>one side is unglazed con un lado sin esmaltar avec un côté non émaillé eine Seite unglasiert одна сторона не покрыта эмалью</p>	 <p>wall-hung installation instalación suspendida installation suspendue wandhängende Montage подвесная установка</p>	 <p>on top installation instalación de apoyo installation à partir du plan Montage auf Platte установка на столешницу</p>	 <p>with 1 hole prepared 3 holes con 1 agujero preinstalado à trois trous \ mit 1-Loch auf 3-Loch durchschlagbar \ одно отверстие с возможностью выполнения трех отверстий</p>	 <p>no tap hole on request sin agujero, solo a petición sans orifice sur demande auf Anfrage ohne Loch без отверстия под смеситель по запросу</p>	 <p>without overflow sin rebosadero sans trop-plein ohne Überlauf без слива-перелива</p>	 <p>with fixing parts fijaciones incluidas fixations incluses inklusive Befestigungen в комплекте с крепежами</p>
 <p>framework mandatory with washbasin and drawer estructura obligatoria con lavabo y cajón \ structure obligatoire avec évier et tiroir obligatorische Struktur mit Spüle und Schublade \ обязательная конструкция с раковиной и ящиком</p>						

Marcel art. MASPRE

Specchio Marcel

Marcel Mirror

cielo
handmade in Italy



PESO NETTO/NET WEIGHT: 29,00 Kg

ATTENZIONE: La pulizia del vetro deve avvenire unicamente tramite l'utilizzo di prodotti **neutri** specifici per gli specchi, i bordi devono sempre essere asciugati rapidamente e completamente.

ATTENTION: Glass cleaning must only be done through the use of specific **neutral** products for mirrors, the edges must always be dried quickly and completely.

FINITURE STRUTTURA

FRAMEWORK FINISHES

legno/wood

● Frassino tinto naturale

● Frassino tinto nero

+

● frontale in paglia di Vienna naturale

NOTE/NOTES

Specchio; Struttura in legno
Mirror; Framework made of wood

NOTE/NOTES

Fissaggi generici inclusi*
Generic fixing kit included*

Ottobre 2022

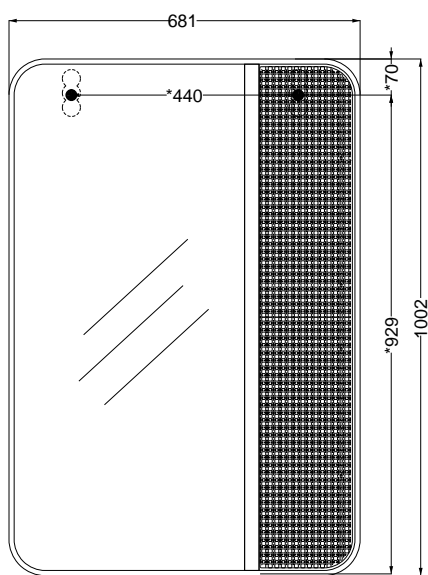

FRONT

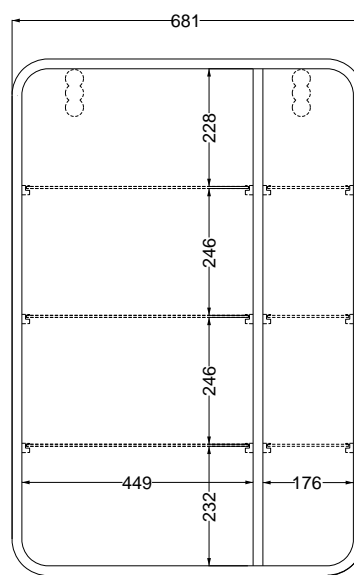

INSIDE

* = fixings

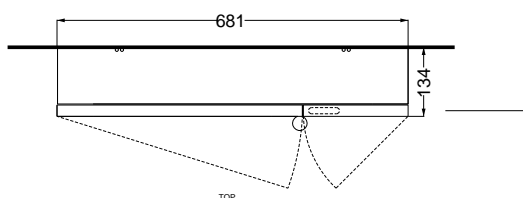

TOP

*ATTENZIONE:

E' di fondamentale importanza verificare che le viti in dotazione siano compatibili con il tipo di parete/supporto/soffitto a cui viene fissato lo specchio. La caduta accidentale dello specchio può causare lesioni da compressione/taglio serie o fatali. L'installatore deve provvedere al controllo della compatibilità del sistema di fissaggio fornito e eventualmente scegliere un sistema idoneo. Ceramica Cielo s.p.a. non risponde di danni diretti o indiretti a cose e/o persone causati dall'inadempimento a tale verifica.

ATTENZIONE:

Le misure d'installazione possono presentare leggere differenze rispetto ai pezzi reali in considerazione delle caratteristiche del prodotto. L'azienda si riserva di cambiare schede tecniche e caratteristiche di funzionamento degli articoli in ogni momento e senza necessità di preavviso.

*ATTENTION:

It is absolutely essential to make sure that the screws provided are compatible with the type of wall/ base/ceiling to which the mirror will be attached. If the mirror were to accidentally fall, it could cause serious or fatal injury from cuts or blows. The installer must check the compatibility of the provided attachment system and choose a suitable system if needed. Ceramica Cielo spa is not liable for direct or indirect damages to objects or people caused by a failure to adequately perform this check.

ATTENTION:

Measure details can show some little difference respect real items, following typical characteristics of production. The company reserves the right to change any technical specifications/dimension and/or operating characteristics of the products at any time and without giving notice.