

Pois

Finiture disponibili / Available finishings / Erhältliche Oberflächen / Finitions disponibles / Acabados disponibles :

CRL	CROMO / CHROME / CHROME / CHROME / CROMO
IX	SPAZZOLATO / BRUSHED / GEBÜRSTETEM / BROSSÉ / CEPILLADO
CRB	BLACK CHROME
BLX	BRUSHED BLACK CHROME
DOR	DORATO / GOLD / VERGOLDET / DOREÉ / DORADO
GOX	DORATO SPAZZOLATO / BRUSHED GOLD / GEBÜRSTETEM VERGOLDET / DOREÉ BROSSÉ / DORADO CEPILLADO
CHX	BRUSHED CHAMPAGNE
BRX	BRUSHED BRONZE
C03	BIANCO / WHITE / WEIß / BLANC / BLANCO
C04	NERO / BLACK / SCHWARZ / NOIR / NEGRO
F31	FROSTED BLACK CHROME
F32	ROSE GOLD
F33	BRUSHED ROSE GOLD
F34	DARK BRUSHED BRONZE
F36	FROSTED ROSE GOLD
F37	FROSTED CHAMPAGNE

MISCELATORI PER LAVABO
BASIN MIXERS
MISCHER FÜR WASCHTISCH
MITIGEURS POUR LAVABO
MEZCLADORES PARA LAVABO



PR31AA101 pag. 788	PR31AA201 pag. 788	PR31AA202 pag. 789	PR31AF201 pag. 789	PR31AE201 pag. 790	PR31AH101 pag. 791	PR31AH201 pag. 792	PR31AH102 pag. 793	PR31AH202 pag. 794
-----------------------	-----------------------	-----------------------	-----------------------	-----------------------	-----------------------	-----------------------	-----------------------	-----------------------

MISCELATORI PER BIDET
BIDET MIXERS
MISCHER FÜR BIDET
MITIGEURS POUR BIDET
MEZCLADORES PARA BIDET



PR31BA101 pag. 795	PR31BA201 pag. 795
-----------------------	-----------------------

GRUPPI VASCA
BATH GROUPS
MISCHBATTERIE FÜR BADEWANNE
MITIGEURS POUR BAIGNOIRE
GRUPOS PARA BAÑERA



PR31EA201 pag. 796	PR31EH201 pag. 796	PR31EB101 pag. 797
-----------------------	-----------------------	-----------------------

GRUPPI DOCCIA
SHOWER GROUPS
MISCHBATTERIE FÜR DUSCHE
MITIGEURS POUR DOUCHE
GRUPOS PARA DUCHA

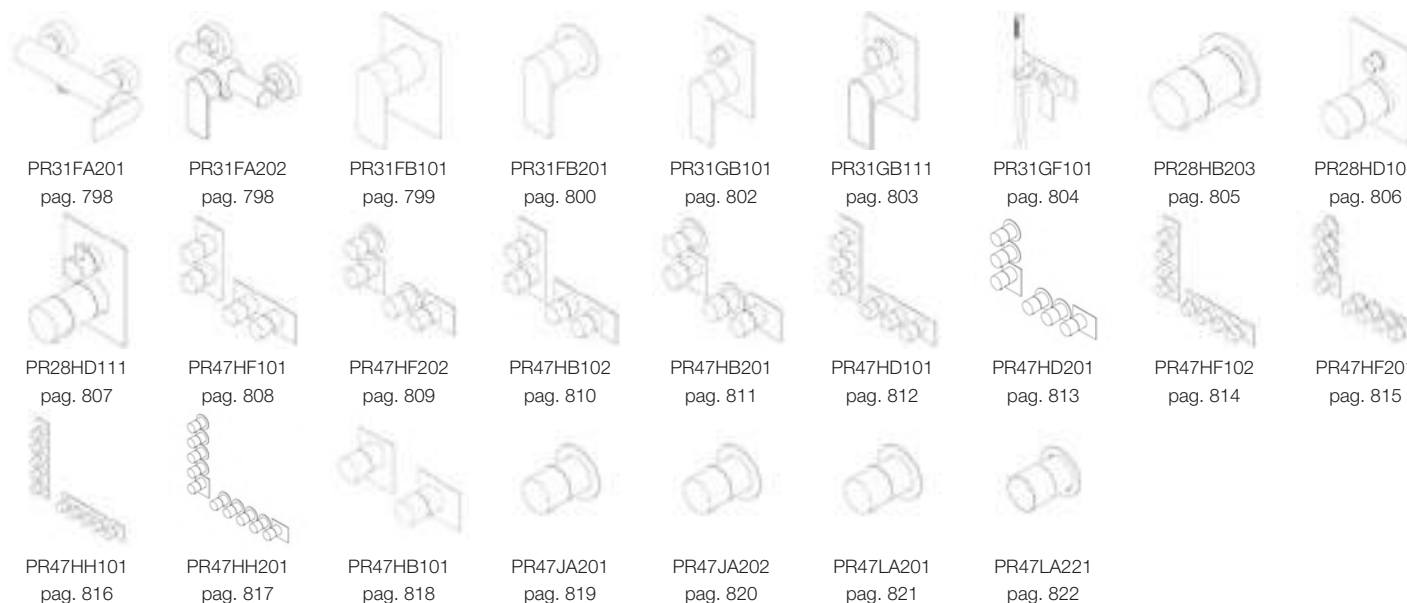

PR31FA201 pag. 798	PR31FA202 pag. 798	PR31FB101 pag. 799	PR31FB201 pag. 800	PR31GB101 pag. 802	PR31GB111 pag. 803	PR31GF101 pag. 804	PR28HB203 pag. 805	PR28HD101 pag. 806
PR28HD111 pag. 807	PR47HF101 pag. 808	PR47HF202 pag. 809	PR47HB102 pag. 810	PR47HB201 pag. 811	PR47HD101 pag. 812	PR47HD201 pag. 813	PR47HF102 pag. 814	PR47HF201 pag. 815
PR47HH101 pag. 816	PR47HH201 pag. 817	PR47HB101 pag. 818	PR47JA201 pag. 819	PR47JA202 pag. 820	PR47LA201 pag. 821	PR47LA221 pag. 822		

BOCCHIE DI EROGAZIONE
SPOUTS
WANDAUSLÄUFE
BECS VERSEURS
CAÑOS



E0BA0185H03
pag. 823



E0BA0185H--
pag. 823



PR31CC201
pag. 824

COMANDI REMOTI
MIXERS
MISCHER
MITIGEURS
MEZCLADORES



PR31AW201
pag. 824



PR31FB101
pag. 825



PR31FB201
pag. 826

POIS

TIE

TIP

TAB

REVERSO

RITRÒ

ELEMENTA
ACCESSORI

ELEMENTA
IMPRONTE
ACCESSORI

ACCESSORI

COMPLEMENTI
WC

PILETTE

SIFONI DI
SCARICO



Miscelatore monocomando per lavabo
Single lever basin mixer
Waschtisch Einhandmischer
Mitigeur monocommande pour lavabo
Mezclador monomando para lavabo













PR31AA101 CRL
IX, CRB, BLX, BRX, C03, C04, F31, F34
DOR, GOX, CHX, F32, F33, F36, F37

Accessori / Accessories / Zubehör / Accessoires / Accesorios

Prolunghe / Extensions / Verlängerungen / Rallonges / Prolongadoras & Ricambi / Spare parts / Ersatzteile / Pièces de rechange / Recambios

								
PR31AA901 pag. 1201	PR31AA902 pag. 1201	RCMB068 pag. 1216	RCMB316 pag. 1218	RCMB435 pag. 1220	RCMB504 pag. 1221	RCMB507 pag. 1221	RCMB612 pag. 1225	RCMB613 pag. 1226

Disponibile sia in versione Eco che Ecoplus, per miscelatore Ecoplus aggiungere E dopo la finitura (es: PR43AU101CRL --> PR43AU101CRLE)

Available in both versions: Eco and Ecoplus, for Ecoplus mixer add E after finishing code (ex: PR43AU101CRL --> PR43AU101CRLE) / Sowohl Version Eco als auch Ecoplus verfügbar, für Ecoplus Mischer bitte nach der Oberfläche den Buchstabe E hinzufügen (z. B. PR43AU101CRL --> PR43AU101CRLE) / Disponible en deux versions: Eco et Ecoplus, pour mitigeur Ecoplus ajouter E après la finition (ex: PR43AU101CRL --> PR43AU101CRLE) / Disponible en versión Eco y Ecoplus, para mezclador Ecoplus añadir E después el acabado (es: PR43AU101CRL --> PR43AU101CRLE)



Miscelatore monocomando per lavabo
Single lever basin mixer
Waschtisch Einhandmischer
Mitigeur monocommande pour lavabo
Mezclador monomando para lavabo





PR31AA201 CRL
IX, CRB, BLX, BRX, C03, C04, F31, F34
DOR, GOX, CHX, F32, F33, F36, F37

Accessori / Accessories / Zubehör / Accessoires / Accesorios

Prolunghe / Extensions / Verlängerungen / Rallonges / Prolongadoras & Ricambi / Spare parts / Ersatzteile / Pièces de rechange / Recambios

								
PR31AA901 pag. 1201	PR31AA902 pag. 1201	RCMB068 pag. 1216	RCMB435 pag. 1220	RCMB504 pag. 1221	RCMB507 pag. 1221	RCMB612 pag. 1225	RCMB613 pag. 1226	

Disponibile sia in versione Eco che Ecoplus, per miscelatore Ecoplus aggiungere E dopo la finitura (es: PR43AU101CRL --> PR43AU101CRLE)

Available in both versions: Eco and Ecoplus, for Ecoplus mixer add E after finishing code (ex: PR43AU101CRL --> PR43AU101CRLE) / Sowohl Version Eco als auch Ecoplus verfügbar, für Ecoplus Mischer bitte nach der Oberfläche den Buchstabe E hinzufügen (z. B. PR43AU101CRL --> PR43AU101CRLE) / Disponible en deux versions: Eco et Ecoplus, pour mitigeur Ecoplus ajouter E après la finition (ex: PR43AU101CRL --> PR43AU101CRLE) / Disponible en versión Eco y Ecoplus, para mezclador Ecoplus añadir E después el acabado (es: PR43AU101CRL --> PR43AU101CRLE)



Miscelatore monocomando per lavabo
Single lever basin mixer
Waschtisch Einhandmischer
Mitigeur monocommande pour lavabo
Mezclador monomando para lavabo



PR31AA202

CRL
IX, CRB, BLX, BRX, C03, C04, F31, F34
DOR, GOX, CHX, F32, F33, F36, F37

Accessori / Accessories / Zubehör / Accessoires / Accesorios

Prolunghe / Extensions / Verlängerungen / Rallonges / Prolongadoras & Ricambi / Spare parts / Ersatzteile / Pièces de rechange / Recambios

							
+120mm	+160mm						
PR31AA901	PR31AA902	RCMB068	RCMB435	RCMB504	RCMB507	RCMB612	RCMB613
pag. 1201	pag. 1201	pag. 1216	pag. 1220	pag. 1221	pag. 1221	pag. 1225	pag. 1226

Disponibile sia in versione Eco che Ecoplus, per miscelatore Ecoplus aggiungere E dopo la finitura (es: PR43AU101CRL --> PR43AU101CRLE)
 Available in both versions: Eco and Ecoplus, for Ecoplus mixer add E after finishing code (ex: PR43AU101CRL --> PR43AU101CRLE) / Sowohl Version Eco als auch Ecoplus verfügbar, für Ecoplus Mischer bitte nach der Oberfläche den Buchstabe E hinzufügen (z. B. PR43AU101CRL --> PR43AU101CRLE) / Disponible en deux versions: Eco et Ecoplus, pour mitigeur Ecoplus ajouter E après la finition (ex: PR43AU101CRL --> PR43AU101CRLE) / Disponible en versión Eco y Ecoplus, para mezclador Ecoplus añadir E después el acabado (es: PR43AU101CRL --> PR43AU101CRLE)



Miscelatore monocomando soprapiano per lavabo
Exposed single lever basin mixer
Waschtisch Standmischbatterie
Mitigeur monocommande sur-plan pour lavabo
Mezclador monomando sobre encimera



PR31AF201

CRL
IX, CRB, BLX, BRX, C03, C04, F31, F34
DOR, GOX, CHX, F32, F33, F36, F37

Accessori / Accessories / Zubehör / Accessoires / Accesorios

Ricambi / Spare parts / Ersatzteile / Pièces de rechange / Recambios

					
RCMB435	RCMB504	RCMB507	RCMB515	RCMB612	RCMB613
pag. 1220	pag. 1221	pag. 1221	pag. 1222	pag. 1225	pag. 1226

Disponibile sia in versione Eco che Ecoplus, per miscelatore Ecoplus aggiungere E dopo la finitura (es: PR43AU101CRL --> PR43AU101CRLE)
 Available in both versions: Eco and Ecoplus, for Ecoplus mixer add E after finishing code (ex: PR43AU101CRL --> PR43AU101CRLE) / Sowohl Version Eco als auch Ecoplus verfügbar, für Ecoplus Mischer bitte nach der Oberfläche den Buchstabe E hinzufügen (z. B. PR43AU101CRL --> PR43AU101CRLE) / Disponible en deux versions: Eco et Ecoplus, pour mitigeur Ecoplus ajouter E après la finition (ex: PR43AU101CRL --> PR43AU101CRLE) / Disponible en versión Eco y Ecoplus, para mezclador Ecoplus añadir E después el acabado (es: PR43AU101CRL --> PR43AU101CRLE)

POIS
 TIE
 TIP
 TAB
 REVERSO
 RITRÒ
 ELEMENTA ACCESSORI
 ELEMENTA IMPRONTA ACCESSORI
 ACCESSORI
 COMPLEMENTI WC
 PILETTE
 SIFONI DI SCARICO



Gruppo a tre fori per lavabo
 Three holes basin group
 Dreiloch Waschtischbatterie
 Groupe trois trous pour lavabo
 Grupo mezclador con bimando para lavabo

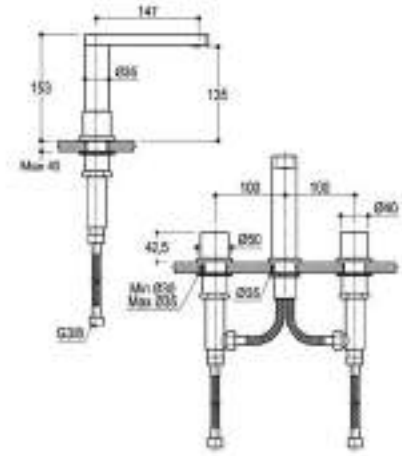

PR31AE201

CRL

IX, CRB, BLX, BRX, C03, C04, F31, F34
 DOR, GOX, CHX, F32, F33, F36, F37

Accessori / Accessories / Zubehör / Accessoires / Accesorios

Ricambi / Spare parts / Ersatzteile / Pièces de rechange / Recambios



RCMB062
 pag. 1215



RCMB507
 pag. 1221



RCMB568
 pag. 1224



RCMB571
 pag. 1224



RCMB573
 pag. 1224



Miscelatore monocomando ad incasso per lavabo
Built-in single lever basin mixer
UP-Einhandmischer für Waschbecken
Mitigeur monocommande à encastrer pour lavabo
Mezclador monomando empotrado para lavabo

_ canna SX Lmax=129mm _ piastra esterna _ completo di parti interne
_ spout SX Lmax=129mm _ external plate _ complete of inner parts
_ Einlaufrohr LI Lmax=129mm _ Montageplatte _ komplett mit UP-Teilen
_ Bec SX Lmax=129mm _ plaque externe _ complet avec parties internes
_ caño SX Lmax=129mm _ plancha externa _ completo de partes internas





Parti esterne
Outer parts / Fertigset / Parties externes / Partes externas

PR31AL101

CRL
IX, CRB, BLX, BRX, C03, C04, F31, F34
DOR, GOX, CHX, F32, F33, F36, F37



Parti da incasso
Built-in parts / UP-teile / Parties internes / Partes internas

E0BA0115SX

Miscelatore completo
Complete mixer / Vollständige Mischer / Mitigeur complete / Mezclador completo

PR31AH101

CRL
IX, CRB, BLX, BRX, C03, C04, F31, F34
DOR, GOX, CHX, F32, F33, F36, F37

Accessori / Accessories / Zubehör / Accessoires / Accesorios

Prolunghe / Extensions / Verlängerungen / Rallonges / Prolongadoras & Ricambi / Spare parts / Ersatzteile / Pièces de rechange / Recambios



+20mm
RCMB054H1
pag. 1202



+40mm
RCMB054H2
pag. 1202



RCMB015
pag. 1213



RCMB505
pag. 1221



RCMB507
pag. 1221



RCMB510
pag. 1221



RCMB513
pag. 1222



RCMB742
pag. 1231

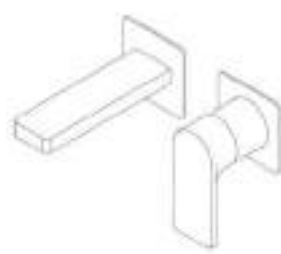

Miscelatore monocomando ad incasso per lavabo
 Built-in single lever basin mixer
 UP-Einhandmischer für Waschbecken
 Mitigeur monocommande à encastrer pour lavabo
 Mezclador monomando empotrado para lavabo

— canna SX Lmax=129mm _ completo di parti interne
 — spout SX Lmax=129mm _ complete of inner parts
 — Einlaufrohr LI Lmax=129mm _ komplett mit UP-Teilen
 — Bec SX Lmax=129mm _ complet avec parties internes
 — caño SX Lmax=129mm _ completo de partes internas

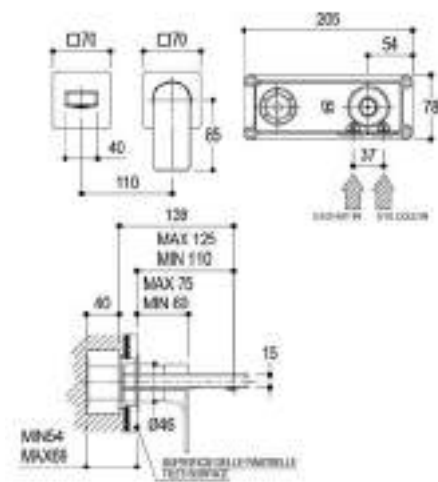

IN

1/2"



Parti esterne
 Outer parts / Fertigset / Parties externes / Partes externas

PR31AL201 **CRL**

IX, CRB, BLX, BRX, C03, C04, F31, F34
DOR, GOX, CHX, F32, F33, F36, F37



Parti da incasso
 Built-in parts / UP-teile / Parties internes / Partes internas

E0BA0115SX

Miscelatore completo
 Complete mixer / Vollständige Mischer / Mitigeur complete / Mezclador completo

PR31AH201 **CRL**

IX, CRB, BLX, BRX, C03, C04, F31, F34
DOR, GOX, CHX, F32, F33, F36, F37

Accessori / Accessories / Zubehör / Accessoires / Accesorios

Prolunghe / Extensions / Verlängerungen / Rallonges / Prolongadoras & Ricambi / Spare parts / Ersatzteile / Pièces de rechange / Recambios



+20mm
RCMB054H1
pag. 1202



+40mm
RCMB054H2
pag. 1202



RCMB015
pag. 1213



RCMB505
pag. 1221



RCMB507
pag. 1221



RCMB511
pag. 1221



RCMB512
pag. 1221



RCMB513
pag. 1222



RCMB742
pag. 1231

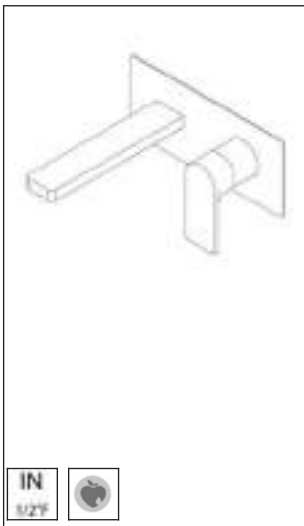

Miscelatore monocomando ad incasso per lavabo

Built-in single lever basin mixer
 UP-Einhandmischer für Waschbecken
 Mitigeur monocommande à encastrer pour lavabo
 Mezclador monomando empotrado para lavabo

_ canna SX Lmax=179mm _ piastra esterna _ completo di parti interne

_ spout SX Lmax=179mm _ external plate _ complete of inner parts
 _ Einlaufrohr LI Lmax=179mm _ Montageplatte _ komplett mit UP-Teilen
 _ Bec SX Lmax=179mm _ plaque externe _ complet avec parties internes
 _ caño SX Lmax=179mm _ plancha externa _ completo de partes internas

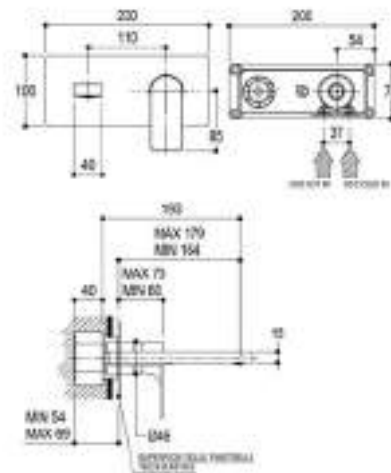

Parti esterne

Outer parts / Fertigset / Parties externes / Partes externas

PR31AL102

CRL

IX, CRB, BLX, BRX, C03, C04, F31, F34
 DOR, GOX, CHX, F32, F33, F36, F37



Parti da incasso

Built-in parts / UP-teile / Parties internes / Partes internas

E0BA0115SX

Miscelatore completo

Complete mixer / Vollständige Mischer / Mitigeur complete / Mezclador completo

PR31AH102

CRL

IX, CRB, BLX, BRX, C03, C04, F31, F34
 DOR, GOX, CHX, F32, F33, F36, F37

Accessori / Accessories / Zubehör / Accessoires / Accesorios

Prolunghe / Extensions / Verlängerungen / Rallonges / Prolongadoras & Ricambi / Spare parts / Ersatzteile / Pièces de rechange / Recambios



RCMB054H1 pag. 1202 RCMB054H2 pag. 1202 RCMB015 pag. 1213 RCMB505 pag. 1221 RCMB507 pag. 1221 RCMB510 pag. 1221 RCMB514 pag. 1222 RCMB742 pag. 1231

POIS
 TIE
 TIP
 TAB
 REVERSO
 RITRÒ
 ELEMENTA ACCESSORI
 ELEMENTA IMPRONTE ACCESSORI
 ACCESSORI
 COMPLEMENTI WC
 PILETTE
 SIFONI DI SCARICO

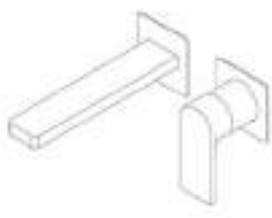

Miscelatore monocomando ad incasso per lavabo
 Built-in single lever basin mixer
 UP-Einhandmischer für Waschbecken
 Mitigeur monocommande à encastrer pour lavabo
 Mezclador monomando empotrado para lavabo

- canna SX Lmax=179mm _ completo di parti interne
- spout SX Lmax=179mm _ complete of inner parts
- Einlaufrohr LI Lmax=179mm _ komplett mit UP-Teilen
- Bec SX Lmax=179mm _ complet avec parties internes
- caño SX Lmax=179mm _ completo de partes internas

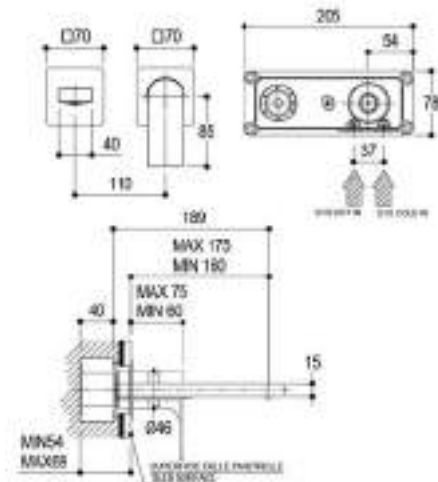

IN

1/2"





Parti esterne
 Outer parts / Fertigset / Parties externes / Partes externas

PR31AL202 **CRL**

IX, CRB, BLX, BRX, C03, C04, F31, F34

DOR, GOX, CHX, F32, F33, F36, F37



Parti da incasso
 Built-in parts / UP-teile / Parties internes / Partes internas

E0BA0115SX



Miscelatore completo
 Complete mixer / Vollständige Mischer / Mitigeur complete / Mezclador completo

PR31AH202 **CRL**

IX, CRB, BLX, BRX, C03, C04, F31, F34

DOR, GOX, CHX, F32, F33, F36, F37

Accessori / Accessories / Zubehör / Accessoires / Accesorios

Prolunghe / Extensions / Verlängerungen / Rallonges / Prolongadoras & Ricambi / Spare parts / Ersatzteile / Pièces de rechange / Recambios



+20mm
RCMB054H1
pag. 1202



+40mm
RCMB054H2
pag. 1202



RCMB015
pag. 1213



RCMB505
pag. 1221



RCMB507
pag. 1221



RCMB511
pag. 1221



RCMB512
pag. 1221



RCMB514
pag. 1222



RCMB742
pag. 1231



Miscelatore monocomando per bidet
Single lever bidet mixer
Einhandbidetmischer
Mitigeur monocommande pour bidet
Mezclador monomando para bidet





PR31BA101 **CRL**
IX, CRB, BLX, BRX, C03, C04, F31, F34
DOR, GOX, CHX, F32, F33, F36, F37

Accessori / Accessories / Zubehör / Accessoires / Accesorios

Prolunghe / Extensions / Verlängerungen / Rallonges / Prolongadoras & Ricambi / Spare parts / Ersatzteile / Pièces de rechange / Recambios

									
+120mm	+150mm								
PR31AA901	PR31AA902	RCMB019	RCMB068	RCMB316	RCMB435	RCMB476	RCMB504	RCMB612	RCMB613
pag. 1201	pag. 1201	pag. 1214	pag. 1216	pag. 1218	pag. 1220	pag. 1220	pag. 1221	pag. 1225	pag. 1226

Disponibile sia in versione Eco che Ecoplus, per miscelatore Ecoplus aggiungere E dopo la finitura (es: PR43AU101CRL --> PR43AU101CRLE)

Available in both versions: Eco and Ecoplus, for Ecoplus mixer add E after finishing code (ex: PR43AU101CRL --> PR43AU101CRLE) / Sowohl Version Eco als auch Ecoplus verfügbar, für Ecoplus Mischer bitte nach der Oberfläche den Buchstabe E hinzufügen (z. B. PR43AU101CRL --> PR43AU101CRLE) / Disponible en deux versions: Eco et Ecoplus, pour mitigeur Ecoplus ajouter E après la finition (ex: PR43AU101CRL --> PR43AU101CRLE) / Disponible en versión Eco y Ecoplus, para mezclador Ecoplus añadir E después el acabado (es: PR43AU101CRL --> PR43AU101CRLE)



Miscelatore monocomando per bidet
Single lever bidet mixer
Einhandbidetmischer
Mitigeur monocommande pour bidet
Mezclador monomando para bidet





PR31BA201 **CRL**
IX, CRB, BLX, BRX, C03, C04, F31, F34
DOR, GOX, CHX, F32, F33, F36, F37

Accessori / Accessories / Zubehör / Accessoires / Accesorios

Prolunghe / Extensions / Verlängerungen / Rallonges / Prolongadoras & Ricambi / Spare parts / Ersatzteile / Pièces de rechange / Recambios

								
+120mm	+150mm							
PR31AA901	PR31AA902	RCMB019	RCMB068	RCMB435	RCMB476	RCMB504	RCMB612	RCMB613
pag. 1201	pag. 1201	pag. 1214	pag. 1216	pag. 1220	pag. 1220	pag. 1221	pag. 1225	pag. 1226

Disponibile sia in versione Eco che Ecoplus, per miscelatore Ecoplus aggiungere E dopo la finitura (es: PR43AU101CRL --> PR43AU101CRLE)

Available in both versions: Eco and Ecoplus, for Ecoplus mixer add E after finishing code (ex: PR43AU101CRL --> PR43AU101CRLE) / Sowohl Version Eco als auch Ecoplus verfügbar, für Ecoplus Mischer bitte nach der Oberfläche den Buchstabe E hinzufügen (z. B. PR43AU101CRL --> PR43AU101CRLE) / Disponible en deux versions: Eco et Ecoplus, pour mitigeur Ecoplus ajouter E après la finition (ex: PR43AU101CRL --> PR43AU101CRLE) / Disponible en versión Eco y Ecoplus, para mezclador Ecoplus añadir E después el acabado (es: PR43AU101CRL --> PR43AU101CRLE)

POIS

TIE

TIP

TAB

REVERSO

RITRÒ

ELEMENTA ACCESSORI

ELEMENTA IMPRONTA ACCESSORI

ACCESSORI

COMPLEMENTI WC

PILETTE

SIFONI DI SCARICO

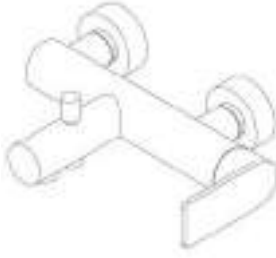

Miscelatore monocomando esterno per vasca
External single lever bath mixer
AP- Einhandmischer für Badewanne
Mitigeur monocommande externe pour baignoire
Mezclador monomando externo para bañera

due uscite _ deviatore automatico vasca/doccia
_ two ways _ automatic diverter bath/shower
_ zwei Abgänge _ automatische Umstellung von Wanne auf Dusche
_ deux sorties _ inverseur automatique bain/douche
_ dos salidas _ desviador automático bañera/ducha

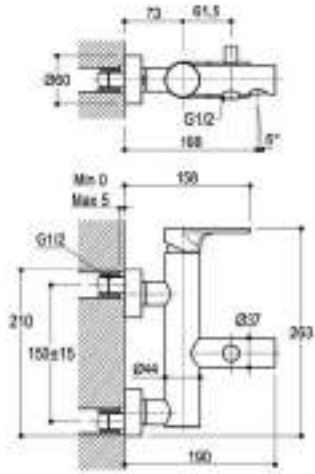

IN
1/2" M

OUT
1/2" M

PR31EA201 **CRL**
IX, CRB, BLX, BRX, C03, C04, F31, F34
DOR, GOX, CHX, F32, F33, F36, F37

Accessori / Accessories / Zubehör / Accessoires / Accesorios

Ricambi / Spare parts / Ersatzteile / Pièces de rechange / Recambios



RCMB007H1
pag. 1213



RCMB114
pag. 1216



RCMB321
pag. 1219



RCMB506
pag. 1221



RCMB651
pag. 1228



Miscelatore monocomando esterno per vasca
External single lever bath mixer
AP- Einhandmischer für Badewanne
Mitigeur monocommande externe pour baignoire
Mezclador monomando externo para bañera

due uscite _ deviatore automatico vasca/doccia _ doccetta Ø24mm in ottone con flessibile da 1500mm _ getto fisso
_ two ways _ automatic diverter bath/shower _ Ø24mm brass hand shower with 1500mm flexible hose _ fixed jet
_ zwei Abgänge _ automatische Umstellung von Wanne auf Dusche _ Handbrause Ø24mm aus messing mit Schlauch 1500mm _ feststehender Strahl
_ deux sorties _ inverseur automatique bain/douche _ douchette Ø24mm en laiton avec flexible de 1500mm _ jet fixe
_ dos salidas _ desviador automático bañera/ducha _ ducha teléfono Ø24mm en latón con flexible de 1500mm _ chorro fijo

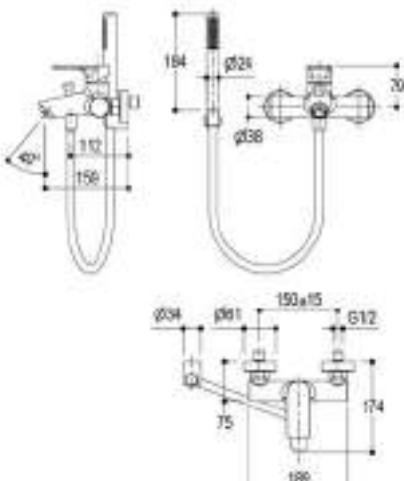

IN
1/2" M

PR31EH201 **CRL**

Accessori / Accessories / Zubehör / Accessoires / Accesorios

Ricambi / Spare parts / Ersatzteile / Pièces de rechange / Recambios



RCMB321
pag. 1219



RCMB506
pag. 1221



RCMB566
pag. 1223



RCMB567
pag. 1224



Miscelatore monocomando ad incasso per vasca
*Built-in single lever bath mixer
 Einhandmischer für Badewanne
 Mitigeur monocommande à encastrer pour baignoire
 Mezclador monomando empotrado para bañera*

**_ miscelatore monocomando a due uscite con deviatore automatico
 bocca di erogazione/doccetta _ bocca di erogazione L=182mm _
 doccetta Ø24mm in ottone con flessibile da 1500mm _ completo di
 parti interne**
*_ single lever mixer with two outlets with automatic diverter spout/hand
 shower _ spout L=182mm _ Ø24mm brass hand shower with 1500mm
 flexible hose _ complete of inner parts
 _ zwei Abgänge Einhandmischer mit automatischem Umsteller
 Auslauf/Brause _ Wandauslauf L=182mm _ Handbrause Ø24mm aus
 messing mit Schlauch 1500mm _ komplett mit UP-Teilen
 _ deux sorties mitigeur monocommande avec inverseur automatique
 bec/douchette _ bec verseur L=182mm _ douchette Ø24mm en laiton avec
 flexible de 1500mm _ complet avec parties internes
 _ mezclador monomando dos salidas con desviador automático
 caño/duchita _ caño L=182mm _ ducha teléfono Ø24mm en latón con
 flexible de 1500mm _ completo de partes internas*



IN
3x1/2" / 1 1/2"

OUT
1/2"



Parti esterne
*Outer parts / Fertigset / Parties externes / Partes
 externas*

PR31EC101

CRL
 IX, CRB, BLX, BRX, C03, C04, F31, F34
 DOR, GOX, CHX, F32, F33, F36, F37



Parti da incasso
*Built-in parts / UP-teile / Parties internes / Partes
 internas*

PM0020D

Miscelatore completo
*Complete mixer / Vollständige Mischer / Mitigeur
 complete / Mezclador completo*

PR31EB101

CRL
 IX, CRB, BLX, BRX, C03, C04, F31, F34
 DOR, GOX, CHX, F32, F33, F36, F37

Accessori / Accessories / Zubehör / Accessoires / Accesorios

Prolunghe / Extensions / Verlängerungen / Rallonges / Prolongadoras & Ricambi / Spare parts / Ersatzteile / Pièces de rechange / Recambios

										
RCMB521H1 pag. 1203	RCMB521H2 pag. 1203	RCMB015 pag. 1213	RCMB035 pag. 1214	RCMB505 pag. 1221	RCMB512 pag. 1221	RCMB519 pag. 1222	RCMB522 pag. 1222	RCMB526 pag. 1222	RCMB718 pag. 1230	RCMB742 pag. 1231

POIS

TIE

TIP

TAB

REVERSO

RITRÒ

ELEMENTA
ACCESSORI

ELEMENTA
IMPRONTE
ACCESSORI

ACCESSORI

COMPLEMENTI
WC

PILETTE

SIFONI DI
SCARICO



Miscelatore monocomando esterno per doccia
External single lever shower mixer
AP- Einhandmischer für Dusche
Mitigeur monocommande externe pour douche
Mezclador monomando externo para ducha

_ una uscita
 _ one way
 _ Ein Abgang
 _ une sortie
 _ una salida

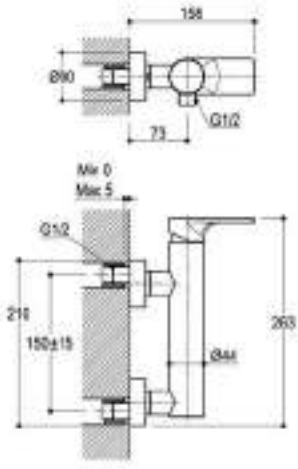

IN
1/2" M

OUT
1/2" M

PR31FA201 CRL
IX, CRB, BLX, BRX, C03, C04, F31, F34
DOR, GOX, CHX, F32, F33, F36, F37

Accessori / Accessories / Zubehör / Accessoires / Accesorios

Ricambi / Spare parts / Ersatzteile / Pièces de rechange / Recambios



RCMB007H1 pag. 1213 RCMB506 pag. 1221 RCMB651 pag. 1228



Miscelatore monocomando esterno per doccia
Outer single lever shower mixer
AP- Einhandmischer für Dusche
Mitigeur monocommande externe pour douche
Mezclador monomando externo para ducha

_ una uscita
 _ one way
 _ Ein Abgang
 _ une sortie
 _ una salida

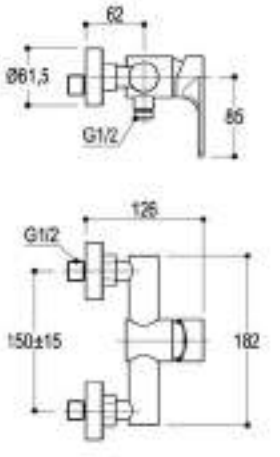

IN
1/2" M

OUT
1/2" M

PR31FA202 CRL

Accessori / Accessories / Zubehör / Accessoires / Accesorios

Ricambi / Spare parts / Ersatzteile / Pièces de rechange / Recambios

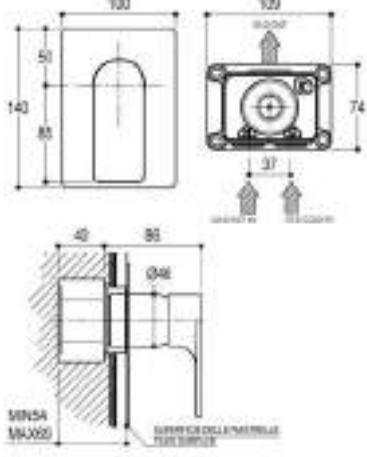

RCMB506 pag. 1221 RCMB778 pag. 1232

	<p>Miscelatore monocomando ad incasso per doccia/lavabo <i>Built-in single lever shower/basin mixer</i> <i>UP-Einhandmischer für Dusche/Waschtisch</i> <i>Mitigeur monocommande à encastrer pour douche/lavabo</i> <i>Mezclador monomando empotrado para ducha/lavabo</i></p> <hr/> <p>_ piastra esterna _ una uscita _ completo di parti interne <i>_ external plate _ one way _ complete of inner parts</i> <i>_ Montageplatte _ Ein Abgang _ komplett mit UP-Teilen</i> <i>_ plaque externe _ une sortie _ complet avec parties internes</i> <i>_ plancha externa _ una salida _ completo de partes internas</i></p>	
<p>IN 1/2"</p> <p>OUT 1/2"</p>		

	<p>Parti esterne <i>Outer parts / Fertigset / Parties externes / Partes externas</i></p>	<p>PR31FC101 CRL <i>IX, CRB, BLX, BRX, C03, C04, F31, F34</i> <i>DOR, GOX, CHX, F32, F33, F36, F37</i></p>
---	--	--

	<p>Parti da incasso <i>Built-in parts / UP-teile / Parties internes / Partes internas</i></p>	<p>E0BA0143</p>
--	---	------------------------

<p>Miscelatore completo <i>Complete mixer / Vollständige Mischer / Mitigeur complete / Mezclador completo</i></p>	<p>PR31FB101 CRL <i>IX, CRB, BLX, BRX, C03, C04, F31, F34</i> <i>DOR, GOX, CHX, F32, F33, F36, F37</i></p>
---	--

Accessori / Accessories / Zubehör / Accessoires / Accesorios

Prolunghe / Extensions / Verlängerungen / Rallonges / Prolongadoras & Ricambi / Spare parts / Ersatzteile / Pièces de rechange / Recambios

 <p>+20mm RCMB054H1 pag. 1202</p>	 <p>+40mm RCMB054H2 pag. 1202</p>	 <p>RCMB015 pag. 1213</p>	 <p>RCMB505 pag. 1221</p>	 <p>RCMB508 pag. 1221</p>	 <p>RCMB742 pag. 1231</p>
---	---	--	--	--	--

POIS
TIE
TIP
TAB
REVERSO
RITRÒ
ELEMENTA ACCESSORI
ELEMENTA IMPRONTA ACCESSORI
ACCESSORI
COMPLEMENTI WC
PILETTI
SIFONI DI SCARICO

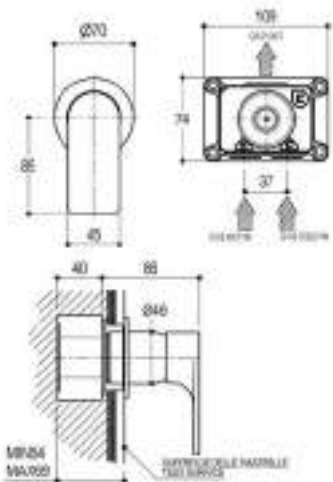
	<p>Miscelatore monocomando ad incasso per doccia/lavabo <i>Built-in single lever shower/basin mixer</i> <i>UP-Einhandmischer für Dusche/Waschtisch</i> <i>Mitigeur monocommande à encastrer pour douche/lavabo</i> <i>Mezclador monomando empotrado para ducha/lavabo</i></p> <hr/> <p>una uscita _ completo di parti interne <i>one way _ complete of inner parts</i> <i>Ein Abgang _ komplett mit UP-Teilen</i> <i>une sortie _ complet avec parties internes</i> <i>una salida _ completo de partes internas</i></p>	
<p>IN 1/2"</p> <p>OUT 1/2"</p>		

	<p>Parti esterne <i>Outer parts / Fertigset / Parties externes / Partes externas</i></p>	<p>PR31FC201 CRL IX, CRB, BLX, BRX, C03, C04, F31, F34 DOR, GOX, CHX, F32, F33, F36, F37</p>
---	--	--

	<p>Parti da incasso <i>Built-in parts / UP-teile / Parties internes / Partes internas</i></p>	<p>E0BA0143</p>
--	---	------------------------

<p>Miscelatore completo <i>Complete mixer / Vollständige Mischer / Mitigeur complete / Mezclador completo</i></p>	<p>PR31FB201 CRL IX, CRB, BLX, BRX, C03, C04, F31, F34 DOR, GOX, CHX, F32, F33, F36, F37</p>
---	--

Accessori / Accessories / Zubehör / Accessoires / Accesorios

Prolunghe / Extensions / Verlängerungen / Rallonges / Prolongadoras & Ricambi / Spare parts / Ersatzteile / Pièces de rechange / Recambios

					
+20mm RCMB054H1 pag. 1202	+40mm RCMB054H2 pag. 1202	RCMB015 pag. 1213	RCMB462H1 pag. 1220	RCMB505 pag. 1221	RCMB742 pag. 1231

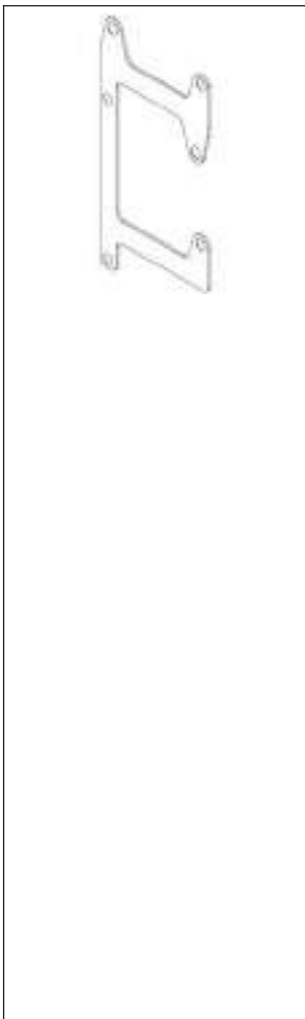

Staffa verticale di fissaggio per miscelatore incasso doppio
 Fixing brackets for double shower mixer for vertical installation
 Vertikale Montagehalterung für UP-Doppel-Mischer
 Support de fixation pour double mitigeur de douche à encastrer en vertical
 Soporte de montaje para mezclador empotrado vertical doble

per ·Diametro35_0139SP-0140(S/P) ·Diametro35_Impronte-PR51-
FM101-FM201 ·Diametro35_S-PR52 ·FB101-FB201-LA221
 ·Diametro35_Cross-PR53 ·FB101-FB201 ·Diametro35_Elegance-PR54-
FB101-FB201 ·Diametro35_Inox_0139SP-0140(S/P)
 ·Diametro35_Inox_Concrete_0139SP-0140(S/P) ·Reverso ·6040(S/P)
 ·Pois-PR31 ·FB101-FB201 ·Glitter-PR32 ·FB101-FB201 ·Tie-PR34-
FB101-FB201 ·Taormina-PR35 ·LA221 ·Tab-PR37 ·FB101-FB201
·Tip-PR38 ·FB101-FB201 ·Haptic-PR43 ·FM101-FM201-LA221
 ·DOT316-PR50 ·FB111-FB201-FB211-FB221-LA221
 ·Comandi_Wellness-PR28 ·HB203-HB204-HB205
 ·Comandi_Wellness-PR47 ·LA221-LA231
 für ·Diametro35_0139SP-0140(S/P) ·Diametro35_Impronte-PR51-
 FM101-FM201 ·Diametro35_S-PR52 ·FB101-FB201-LA221
 ·Diametro35_Cross-PR53 ·FB101-FB201 ·Diametro35_Elegance-PR54-
 FB101-FB201 ·Diametro35_Inox_0139SP-0140(S/P)
 ·Diametro35_Inox_Concrete_0139SP-0140(S/P) ·Reverso ·6040(S/P)
 ·Pois-PR31 ·FB101-FB201 ·Glitter-PR32 ·FB101-FB201 ·Tie-PR34-
 FB101-FB201 ·Taormina-PR35 ·LA221 ·Tab-PR37 ·FB101-FB201 ·Tip-PR38-
 FB101-FB201 ·Haptic-PR43 ·FM101-FM201-LA221 ·DOT316-PR50-
 FB111-FB201-FB211-FB221-LA221 ·Comandi_Wellness-PR28-
 HB203-HB204-HB205 ·Comandi_Wellness-PR47 ·LA221-LA231
 pour ·Diametro35_0139SP-0140(S/P) ·Diametro35_Impronte-PR51-
 FM101-FM201 ·Diametro35_S-PR52 ·FB101-FB201-LA221
 ·Diametro35_Cross-PR53 ·FB101-FB201 ·Diametro35_Elegance-PR54-
 FB101-FB201 ·Diametro35_Inox_0139SP-0140(S/P)
 ·Diametro35_Inox_Concrete_0139SP-0140(S/P) ·Reverso ·6040(S/P)
 ·Pois-PR31 ·FB101-FB201 ·Glitter-PR32 ·FB101-FB201 ·Tie-PR34-
 FB101-FB201 ·Taormina-PR35 ·LA221 ·Tab-PR37 ·FB101-FB201 ·Tip-PR38-
 FB101-FB201 ·Haptic-PR43 ·FM101-FM201-LA221 ·DOT316-PR50-
 FB111-FB201-FB211-FB221-LA221 ·Comandi_Wellness-PR28-
 HB203-HB204-HB205 ·Comandi_Wellness-PR47 ·LA221-LA231
 para ·Diametro35_0139SP-0140(S/P) ·Diametro35_Impronte-PR51-
 FM101-FM201 ·Diametro35_S-PR52 ·FB101-FB201-LA221
 ·Diametro35_Cross-PR53 ·FB101-FB201 ·Diametro35_Elegance-PR54-
 FB101-FB201 ·Diametro35_Inox_0139SP-0140(S/P)
 ·Diametro35_Inox_Concrete_0139SP-0140(S/P) ·Reverso ·6040(S/P)
 ·Pois-PR31 ·FB101-FB201 ·Glitter-PR32 ·FB101-FB201 ·Tie-PR34-
 FB101-FB201 ·Taormina-PR35 ·LA221 ·Tab-PR37 ·FB101-FB201 ·Tip-PR38-
 FB101-FB201 ·Haptic-PR43 ·FM101-FM201-LA221 ·DOT316-PR50-
 FB111-FB201-FB211-FB221-LA221 ·Comandi_Wellness-PR28-
 HB203-HB204-HB205 ·Comandi_Wellness-PR47 ·LA221-LA231

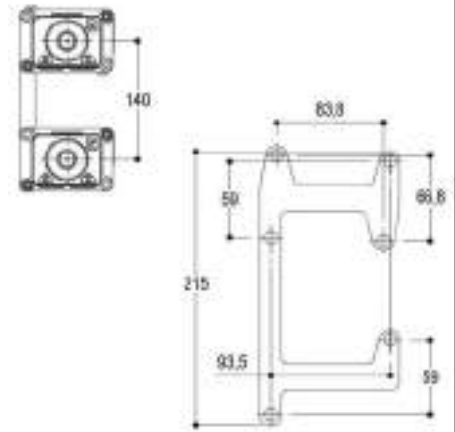

7Z0006

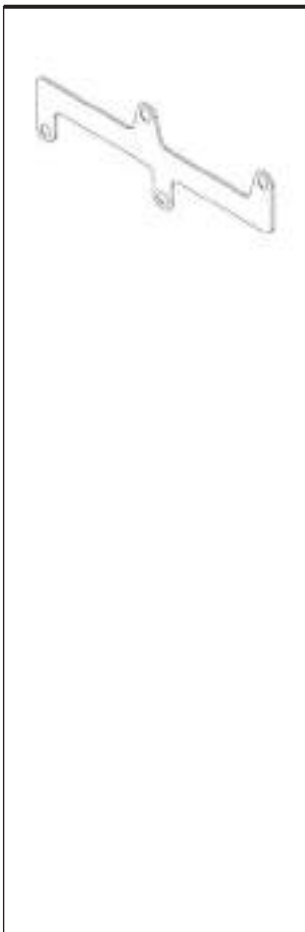

Staffa orizzontale di fissaggio per miscelatore incasso doppio
 Fixing brackets for double shower mixer for horizontal installation
 Horizontale Montagehalterung für UP-Doppel-Mischer
 Support de fixation pour double mitigeur à encastrer en horizontal
 Soporte de montaje para mezclador empotrado horizontal doble

per ·Diametro35_0140(S/P) ·Diametro35_Impronte-PR51-
FM101-FM201 ·Diametro35_S-PR52 ·FB101-FB201
 ·Diametro35_Cross-PR53 ·FB101-FB201 ·Diametro35_Elegance-PR54-
FB101-FB201 ·Diametro35_Inox_0140(S/P)
 ·Diametro35_Inox_Concrete_0140(S/P) ·Reverso ·6040(S/P)
 ·Pois-PR31 ·FB101-FB201 ·Glitter-PR32 ·FB101-FB201 ·Tie-PR34-
FB101-FB201 ·Tab-PR37 ·FB101-FB201 ·Tip-PR38 ·FB101-FB201
·Haptic-PR43 ·FM101-FM201 ·DOT316-PR50
·FB111-FB201-FB211-FB221 ·Comandi_Wellness-PR28
·HB203-HB204-HB205
 für ·Diametro35_0140(S/P) ·Diametro35_Impronte-PR51 ·FM101-FM201
 ·Diametro35_S-PR52 ·FB101-FB201 ·Diametro35_Cross-PR53-
 FB101-FB201 ·Diametro35_Elegance-PR54 ·FB101-FB201
 ·Diametro35_Inox_0140(S/P) ·Diametro35_Inox_Concrete_0140(S/P)
 ·Reverso ·6040(S/P) ·Pois-PR31 ·FB101-FB201 ·Glitter-PR32 ·FB101-FB201
 ·Tie-PR34 ·FB101-FB201 ·Tab-PR37 ·FB101-FB201 ·Tip-PR38-
 FB101-FB201 ·Haptic-PR43 ·FM101-FM201 ·DOT316-PR50-
 FB111-FB201-FB211-FB221 ·Comandi_Wellness-PR28-
 HB203-HB204-HB205
 pour ·Diametro35_0140(S/P) ·Diametro35_Impronte-PR51 ·FM101-FM201
 ·Diametro35_S-PR52 ·FB101-FB201 ·Diametro35_Cross-PR53-
 FB101-FB201 ·Diametro35_Elegance-PR54 ·FB101-FB201
 ·Diametro35_Inox_0140(S/P) ·Diametro35_Inox_Concrete_0140(S/P)
 ·Reverso ·6040(S/P) ·Pois-PR31 ·FB101-FB201 ·Glitter-PR32 ·FB101-FB201
 ·Tie-PR34 ·FB101-FB201 ·Tab-PR37 ·FB101-FB201 ·Tip-PR38-
 FB101-FB201 ·Haptic-PR43 ·FM101-FM201 ·DOT316-PR50-
 FB111-FB201-FB211-FB221 ·Comandi_Wellness-PR28-
 HB203-HB204-HB205
 para ·Diametro35_0140(S/P) ·Diametro35_Impronte-PR51 ·FM101-FM201
 ·Diametro35_S-PR52 ·FB101-FB201 ·Diametro35_Cross-PR53-
 FB101-FB201 ·Diametro35_Elegance-PR54 ·FB101-FB201
 ·Diametro35_Inox_0140(S/P) ·Diametro35_Inox_Concrete_0140(S/P)
 ·Reverso ·6040(S/P) ·Pois-PR31 ·FB101-FB201 ·Glitter-PR32 ·FB101-FB201
 ·Tie-PR34 ·FB101-FB201 ·Tab-PR37 ·FB101-FB201 ·Tip-PR38-
 FB101-FB201 ·Haptic-PR43 ·FM101-FM201 ·DOT316-PR50-
 FB111-FB201-FB211-FB221 ·Comandi_Wellness-PR28-
 HB203-HB204-HB205

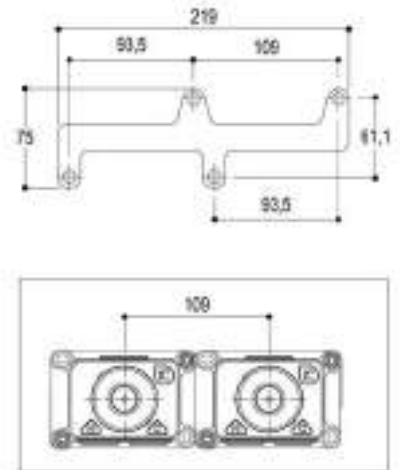

7Z0007

POIS

TIE

TIP

TAB

REVERSO

RITRÒ

ELEMENTA ACCESSORI

ELEMENTA IMPRONTE ACCESSORI

ACCESSORI

COMPLEMENTI WC

PILETTE

SIFONI DI SCARICO



Miscelatore monocomando ad incasso per vasca/doccia
 Built-in single lever bath/shower mixer
 Einhandmischer für Badewanne/Dusche
 Mitigeur monocommande à encastrer pour baignoire/douche
 Mezclador monomando empotrado para bañera/ducha

_ due uscite _ deviatore automatico vasca/doccia _ completo di parti interne
 _ two ways _ automatic diverter bath/shower _ complete of inner parts
 _ zwei Abgänge _ Automatische Umstellung von Wanne auf Dusche _ komplett mit UP-Teilen
 _ deux sorties _ inverseur automatique bain/douche _ complet avec parties internes
 _ dos salidas _ desviador automático bañera/ducha _ completo de partes internas

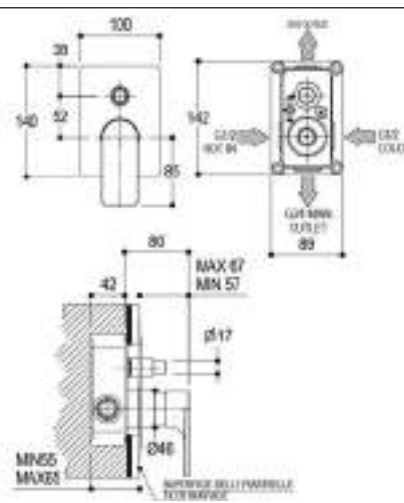

Parti esterne
 Outer parts / Fertigset / Parties externes / Partes externas

PR31GC101

CRL
 IX, CRB, BLX, BRX, C03, C04, F31, F34
 DOR, GOX, CHX, F32, F33, F36, F37



Parti da incasso
 Built-in parts / UP-teile / Parties internes / Partes internas

E0BA0153



Miscelatore completo
 Complete mixer / Vollständige Mischer / Mitigeur complete / Mezclador completo

PR31GB101

CRL
 IX, CRB, BLX, BRX, C03, C04, F31, F34
 DOR, GOX, CHX, F32, F33, F36, F37

Accessori / Accessories / Zubehör / Accessoires / Accesorios

Prolunghe / Extensions / Verlängerungen / Rallonges / Prolongadoras & Ricambi / Spare parts / Ersatzteile / Pièces de rechange / Recambios

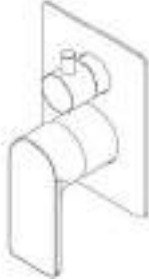
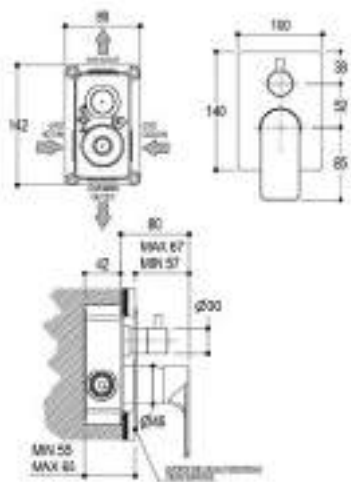

RCMB069H1 pag. 1202 RCMB069H2 pag. 1203 RCMB015 pag. 1213 RCMB035 pag. 1214 RCMB505 pag. 1221 RCMB509 pag. 1221 RCMB526 pag. 1222 RCMB742 pag. 1231

	<p>Miscelatore monocomando ad incasso per vasca/doccia <i>Built-in single lever bath/shower mixer</i> <i>Einhandmischer für Badewanne/Dusche</i> <i>Mitigeur monocommande à encastrer pour baignoire/douche</i> <i>Mezclador monomando empotrado para bañera/ducha</i></p> <hr/> <p>due uscite con deviatore rotativo _ completo di parti interne <i>two ways with rotative diverter _ complete of inner parts</i> <i>zwei Abgänge mit Drehumsteller _ komplett mit UP-Teilen</i> <i>deux sorties avec inverseur rotatif _ complet avec parties internes</i> <i>dos salidas con mando desviador giratorio _ completo de partes internas</i></p>	
<p>IN 1/2" OUT 1/2"</p>		

	<p>Parti esterne <i>Outer parts / Fertigset / Parties externes / Partes externas</i></p>	<p>PR31GC111 CRL IX, CRB, BLX, BRX, C03, C04, F31, F34 DOR, GOX, CHX, F32, F33, F36, F37</p>
---	--	---

	<p>Parti da incasso <i>Built-in parts / UP-teile / Parties internes / Partes internas</i></p>	<p>PM0020M</p>
--	---	-----------------------

<p>Miscelatore completo <i>Complete mixer / Vollständige Mischer / Mitigeur complete / Mezclador completo</i></p>	<p>PR31GB111 CRL IX, CRB, BLX, BRX, C03, C04, F31, F34 DOR, GOX, CHX, F32, F33, F36, F37</p>
---	---

Accessori / Accessories / Zubehör / Accessoires / Accesorios

Ricambi / Spare parts / Ersatzteile / Pièces de rechange / Recambios

- | | | | | | |
|---|---|---|---|---|---|
|  |  |  |  |  |  |
| RCMB015 pag. 1213 | RCMB505 pag. 1221 | RCMB742 pag. 1231 | RCMBA108 pag. 1246 | RCMBA153 pag. 1249 | RCMBA173 pag. 1251 |

POIS
TIE
TIP
TAB
REVERSO
RITRÒ
ELEMENTA ACCESSORI
ELEMENTA IMPRONTE ACCESSORI
ACCESSORI
COMPLEMENTI WC
PILETTA
SIFONI DI SCARICO

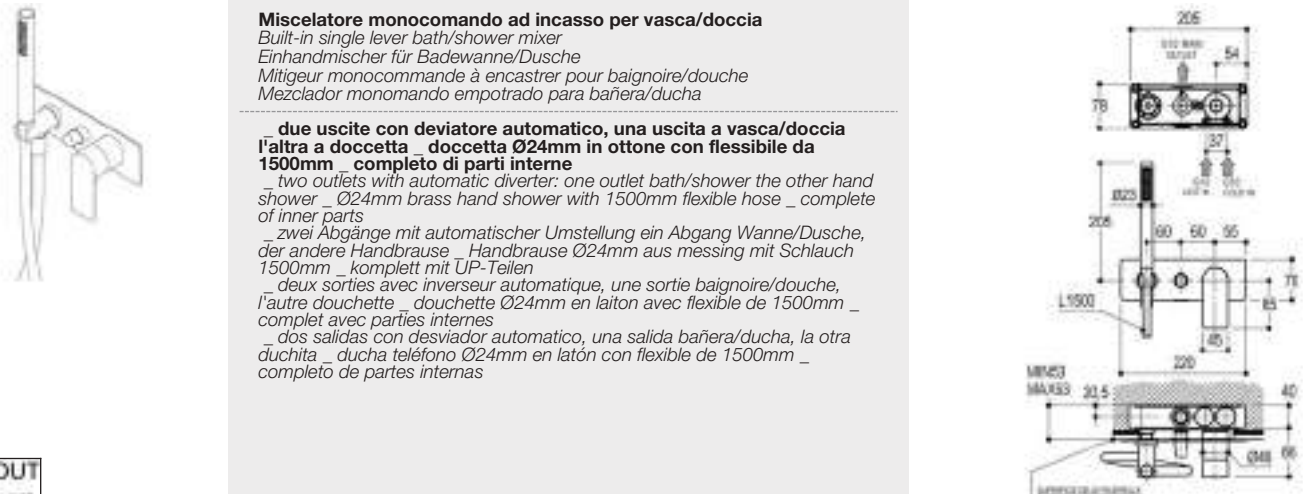

Miscelatore monocomando ad incasso per vasca/doccia
 Built-in single lever bath/shower mixer
 Einhandmischer für Badewanne/Dusche
 Mitigeur monocommande à encastrer pour baignoire/douche
 Mezclador monomando empotrado para bañera/ducha

due uscite con deviatore automatico, una uscita a vasca/doccia l'altra a doccetta - doccetta Ø24mm in ottone con flessibile da 1500mm - completo di parti interne
 two outlets with automatic diverter: one outlet bath/shower the other hand shower - Ø24mm brass hand shower with 1500mm flexible hose - complete of inner parts
 zwei Abgänge mit automatischer Umstellung ein Abgang Wanne/Dusche, der andere Handbrause - Handbrause Ø24mm aus messing mit Schlauch 1500mm - komplett mit UP-Teilen
 deux sorties avec inverseur automatique, une sortie baignoire/douche, l'autre douchette - douchette Ø24mm en laiton avec flexible de 1500mm - complet avec parties internes
 dos salidas con desviador automatico, una salida bañera/ducha, la otra duchita - ducha teléfono Ø24mm en latón con flexible de 1500mm - completo de partes internas

IN 1/2" **OUT** 1/2"



Parti esterne
 Outer parts / Fertigset / Parties externes / Partes externas

PR31GG101 **CRL**
 IX, CRB, BLX, BRX, C03, C04, F31, F34
 DOR, GOX, CHX, F32, F33, F36, F37



Parti da incasso
 Built-in parts / UP-teile / Parties internes / Partes internas

PM0020D

Miscelatore completo
 Complete mixer / Vollständige Mischer / Mitigeur complete / Mezclador completo

PR31GF101 **CRL**
 IX, CRB, BLX, BRX, C03, C04, F31, F34
 DOR, GOX, CHX, F32, F33, F36, F37

Accessori / Accessories / Zubehör / Accessoires / Accesorios

Prolunghe / Extensions / Verlängerungen / Rallonges / Prolongadoras & Ricambi / Spare parts / Ersatzteile / Pièces de rechange / Recambios



+20mm RCMB521H1 pag. 1203
 +40mm RCMB521H2 pag. 1203
 RCMB015 pag. 1213
 RCMB035 pag. 1214
 RCMB505 pag. 1221
 RCMB519 pag. 1222
 RCMB526 pag. 1222
 RCMB742 pag. 1231



Miscelatore termostatico ad incasso
Built-in thermostatic mixer
Thermostat UP-Mischer
Mitigeur thermostatique à encastrer
Mezclador termostático empotrado

_ regolatore di portata _ una uscita _ completo di parti interne
_ flow regulator _ one way _ with inner parts
_ Absperrung _ Ein Abgang _ mit UP-Teilen
_ régulateur de débit _ une sortie _ avec parties internes
_ regulador de caudal _ una salida _ completo de partes internas

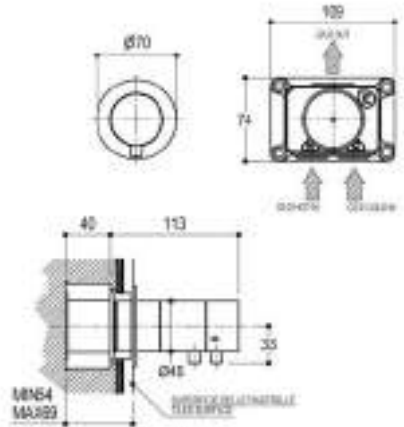

IN
1/2"

OUT
1/2"



Parti esterne
Outer parts / Fertigset / Parties externes / Partes externas

PR28HC203 **CRL**
IX, CRB, BLX, F31
DOR, GOX, CHX, F32, F33, F36, F37



Parti da incasso
Built-in parts / UP-teile / Parties internes / Partes internas

PM0030D **CRL**
IX, CRB, BLX, F31
DOR, GOX, CHX, F32, F33, F36, F37

Miscelatore completo
Complete mixer / Vollständige Mischer / Mitigeur complete / Mezclador completo

PR28HB203 **CRL**
IX, CRB, BLX, F31
DOR, GOX, CHX, F32, F33, F36, F37

Accessori / Accessories / Zubehör / Accessoires / Accesorios

Prolunghe / Extensions / Verlängerungen / Rallonges / Prolongadoras & Ricambi / Spare parts / Ersatzteile / Pièces de rechange / Recambios



+20mm
RCMB556H1
pag. 1203



+40mm
RCMB556H2
pag. 1203



RCMB561
pag. 1223



RCMB562
pag. 1223



RCMB563
pag. 1223



RCMB721
pag. 1231



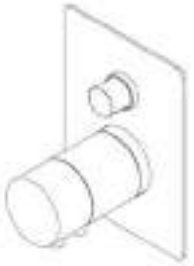

RCMA152
pag. 1249

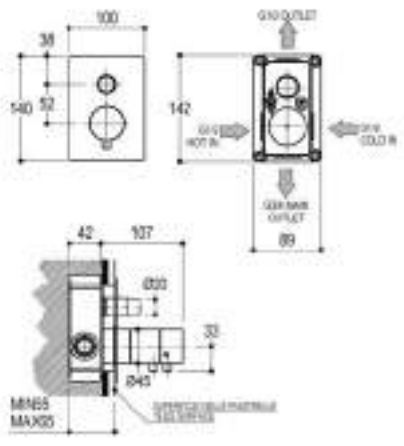

Miscelatore termostatico ad incasso
Built-in thermostatic mixer
UP-Thermostatmischer
Mitigeur thermostatique à encastrer
Mezclador termostático empotrado

regolatore di portata _ due uscite _ completo di parti interne
flow regulator _ two exits _ with inner parts
Absperrung _ zwei Abgänge _ mit UP-Teilen
régulateur de débit _ deux sorties _ avec parties internes
regulador de caudal _ dos salidas _ completo de partes internas





Parti esterne
Outer parts / Fertigset / Parties externes / Partes externas

PR28HE101 **CRL**

IX, CRB, BLX, F31

DOR, GOX, CHX, F32, F33, F36, F37

+



Parti da incasso
Built-in parts / UP-teile / Parties internes / Partes internas

PM0030E **CRL**

IX, CRB, BLX, F31

DOR, GOX, CHX, F32, F33, F36, F37

=

Miscelatore completo
Complete mixer / Vollständige Mischer / Mitigeur complete / Mezclador completo

PR28HD101 **CRL**

IX, CRB, BLX, F31

DOR, GOX, CHX, F32, F33, F36, F37

Accessori / Accessories / Zubehör / Accessoires / Accesorios

Prolunghe / Extensions / Verlängerungen / Rallonges / Prolongadoras & Ricambi / Spare parts / Ersatzteile / Pièces de rechange / Recambios



+20mm
RCMB557H1
pag. 1203



+40mm
RCMB557H2
pag. 1203



RCMB035
pag. 1214



RCMB526
pag. 1222



RCMB561
pag. 1223



RCMB562
pag. 1223



RCMB563
pag. 1223



RCMB721
pag. 1231

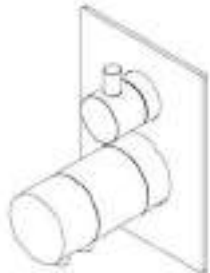
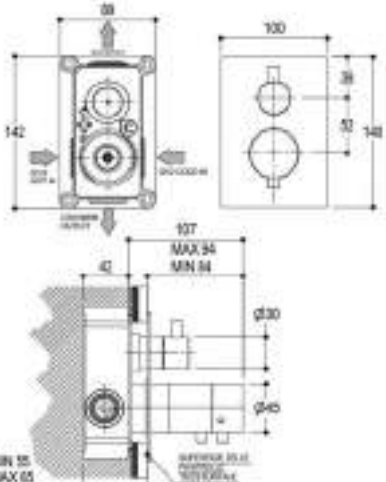

RCMBA116
pag. 1247

 <div data-bbox="199 549 309 606" style="display: flex; justify-content: space-around; font-size: 8px;"> <div style="border: 1px solid black; padding: 2px;">IN 1/2"</div> <div style="border: 1px solid black; padding: 2px;">OUT 1/2"</div> </div>	<p>Miscelatore termostatico ad incasso <i>Built-in thermostatic mixer</i> <i>UP-Thermostatmischer</i> <i>Mitigeur thermostatique à encastrer</i> <i>Mezclador termostático empotrado</i></p> <hr/> <p>_ regolatore di portata _ due uscite con deviatore rotativo _ completo di parti interne <i>_ flow regulator _ two ways with rotative diverter _ with inner parts</i> <i>_ Absperrung _ zwei Abgänge mit Drehumsteller _ mit UP-Teilen</i> <i>_ régulateur de débit _ deux sorties avec inverseur rotatif _ avec parties internes</i> <i>_ regulador de caudal _ dos salidas con mando desviador giratorio _ completo de partes internas</i></p>	
---	---	---

	<p>Parti esterne <i>Outer parts / Fertigset / Parties externes / Partes externas</i></p>	<p>PR28HE111 CRL <i>IX, CRB, BLX, F31</i> <i>DOR, GOX, CHX, F32, F33, F36, F37</i></p>
---	--	---

	<p>Parti da incasso <i>Built-in parts / UP-teile / Parties internes / Partes internas</i></p>	<p>PM0030N CRL <i>IX, CRB, BLX, F31</i> <i>DOR, GOX, CHX, F32, F33, F36, F37</i></p>
--	---	---

<p>Miscelatore completo <i>Complete mixer / Vollständige Mischer / Mitigeur complete / Mezclador completo</i></p>	<p>PR28HD111 CRL <i>IX, CRB, BLX, F31</i> <i>DOR, GOX, CHX, F32, F33, F36, F37</i></p>
---	---

Accessori / Accessories / Zubehör / Accessoires / Accesorios

Ricambi / Spare parts / Ersatzteile / Pièces de rechange / Recambios

						
RCMB561 pag. 1223	RCMB562 pag. 1223	RCMB563 pag. 1223	RCMB721 pag. 1231	RCMBA108 pag. 1246	RCMBA153 pag. 1249	RCMBA157 pag. 1250

POIS
 TIE
 TIP
 TAB
 REVERSO
 RITRÒ
 ELEMENTA ACCESSORI
 ELEMENTA IMPRONTE ACCESSORI
 ACCESSORI
 COMPLEMENTI WC
 PILETTE
 SIFONI DI SCARICO

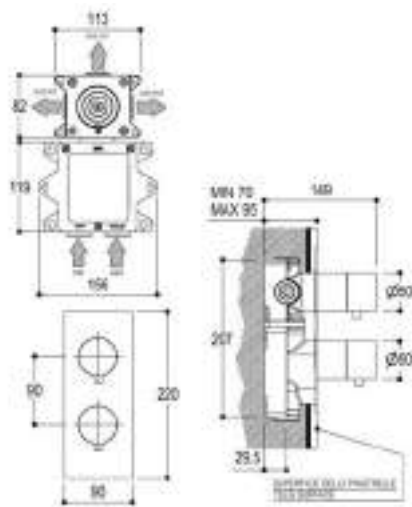

Miscelatore termostatico ad incasso
 Built-in thermostatic mixer
 UP-Thermostatmischer
 Mitigeur thermostatique à encastrer
 Mezclador termostático empotrado

_ regolatore di portata _ due/tre uscite: vasca-doccetta-soffione con posizioni di stop intermedie _ piastra esterna _ filtri e valvole di non ritorno _ completo di parti interne _ installabile in posizione verticale oppure orizzontale
 _ flow regulator _ two/three ways out: bath-hand shower-head shower with intermediate stop positions _ external plate _ filters and non return valves _ with inner parts _ installation in both vertical and horizontal position
 _ Durchflussregler _ Zwei- und Dreiwege-Umstellung: Badewanne-Dusche-Kopfbrause mit Zwischenhaltpositionen
 Montageplatte _ Filter und Rückschlagventil _ mit UP-Teilen _ horizontal oder vertikal installierbar
 _ régulateur de débit _ deux/trois sorties: baignoire-douchette-tête de douche avec positions de stop intermédiaires _ plaque extérieure _ filtres et soupapes de non retour _ avec parties internes _ possible installation en vertical ou horizontal
 _ regulador de caudal _ dos/tres salidas: bañera-ducha teléfono-rociador con posiciones de stop intermedias _ placa externa _ filtros y válvulas sin regreso _ completo de partes internas _ instalación en posición horizontal o vertical

IN 3/4" **OUT** 1/2"



Parti esterne
 Outer parts / Fertigset / Parties externes / Partes externas

PR47HG101 **CRL**
IX, CRB, BLX, BRX, C03, C04, F31, F34
DOR, GOX, CHX, F32, F33, F36, F37



Parti da incasso
 Built-in parts / UP-teile / Parties internes / Partes internas

PM0030K

Miscelatore completo
 Complete mixer / Vollständige Mischer / Mitigeur complete / Mezclador completo

PR47HF101 **CRL**
IX, CRB, BLX, BRX, C03, C04, F31, F34
DOR, GOX, CHX, F32, F33, F36, F37

Accessori / Accessories / Zubehör / Accessoires / Accesorios

Ricambi / Spare parts / Ersatzteile / Pièces de rechange / Recambios



RCMB828 pag. 1235 RCMB829 pag. 1235 RCMB833 pag. 1235 RCMB840 pag. 1235 RCMB909 pag. 1240 RCMB954 pag. 1241 RCMBA020 pag. 1244

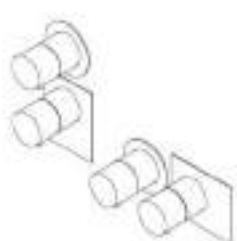

IN
3/4"

OUT
1/2"

Miscelatore termostatico ad incasso
*Built-in thermostatic mixer
 UP-Thermostatmischer
 Mitigeur thermostatique à encastrer
 Mezclador termostático empotrado*

_ regolatore di portata _ due/tre uscite: vasca-doccetta-soffione con posizioni di stop intermedie _ filtri e valvole di non ritorno _ completo di parti interne _ installabile in posizione verticale oppure orizzontale
_ flow regulator _ two/three ways out: bath-hand shower-head shower with intermediate stop positions _ filters and non return valves _ with inner parts _ installation in both vertical and horizontal position
*Durchflussregler _ Zwei- und Dreivege-Umstellung:
 Badewanne-Dusche-Kopfbrause mit Zwischenhaltpositionen _ Filter und Rückschlagventil _ mit UP-Teilen _ horizontal oder vertikal installierbar*
_ régulateur de débit _ deux/trois sorties: baignoire-douchette-tête de douche avec positions de stop intermédiaires _ filtres et soupapes de non retour _ avec parties internes _ possible installation en vertical ou horizontal
_ regulador de caudal _ dos/tres salidas: bañera-ducha teléfono-rociador con posiciones de stop intermedias _ filtros y válvulas sin regreso _ completo de partes internas _ instalación en posición horizontal o vertical

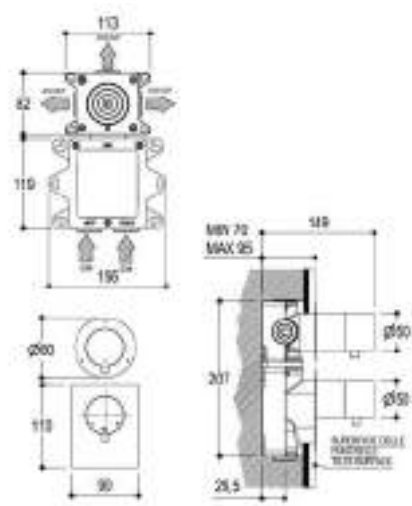



Parti esterne
Outer parts / Fertigset / Parties externes / Partes externas

PR47HG202

CRL
 IX, CRB, BLX, BRX, C03, C04, F31, F34
 DOR, GOX, CHX, F32, F33, F36, F37

TAB



Parti da incasso
Built-in parts / UP-teile / Parties internes / Partes internas

PM0030K

REVERSO

Miscelatore completo
Complete mixer / Vollständige Mischer / Mitigeur complete / Mezclador completo

PR47HF202

CRL
 IX, CRB, BLX, BRX, C03, C04, F31, F34
 DOR, GOX, CHX, F32, F33, F36, F37

RITRÒ

Accessori / Accessories / Zubehör / Accessoires / Accesorios

Ricambi / Spare parts / Ersatzteile / Pièces de rechange / Recambios

- | | | | | | | | |
|---|---|---|---|---|---|--|---|
|  |  |  |  |  |  |  |  |
| RCMB828
pag. 1235 | RCMB829
pag. 1235 | RCMB833
pag. 1235 | RCMB840
pag. 1235 | RCMB909
pag. 1240 | RCMB954
pag. 1241 | RCMB996
pag. 1243 | RCMBA013
pag. 1244 |

POIS
TIE
TIP
TAB
REVERSO
RITRÒ
ELEMENTA ACCESSORI
ELEMENTA IMPRONTE ACCESSORI
ACCESSORI
COMPLEMENTI WC
PILETTE
SIFONI DI SCARICO

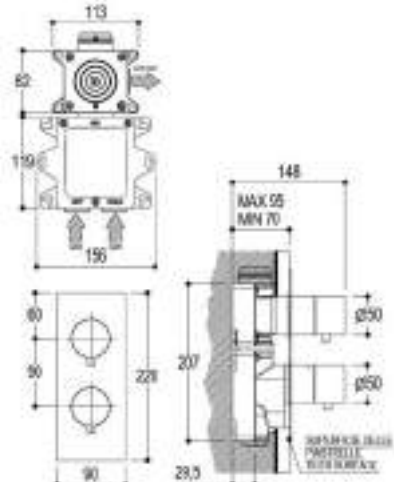

Miscelatore termostatico ad incasso
 Built-in thermostatic mixer
 Thermostat UP-Mischer
 Mitigeur thermostatique à encastrer
 Mezclador termostático empotrado

_ **regolatore di portata** _ **piastra esterna** _ **filtri e valvole di non ritorno**
 _ **una uscita** _ **completo di parti interne** _ **installabile in posizione verticale oppure orizzontale**
 _ flow regulator _ external plate _ filters and non return valves _ one way _
 with inner parts _ installation in both vertical and horizontal position
 _ Absperrung _ Montageplatte _ Filter und Rückschlagventil _ Ein Abgang _
 mit UP-Teilen _ horizontal oder vertikal installierbar
 _ régulateur de débit _ plaque externe _ filtres et soupapes de non retour _
 une sortie _ avec parties internes _ possible installation en vertical ou
 horizontal
 _ regulador de caudal _ plancha externa _ filtros y válvulas sin regreso _ una
 salida _ completo de partes internas _ instalación en posición horizontal o
 vertical

IN 147 **OUT** 147



Parti esterne
 Outer parts / Fertigset / Parties externes / Partes
 externas

PR47HC102 **CRL**
IX, CRB, BLX, BRX, C03, C04, F31, F34
DOR, GOX, CHX, F32, F33, F36, F37



Parti da incasso
 Built-in parts / UP-teile / Parties internes / Partes
 internas

PM0030H

Miscelatore completo
 Complete mixer / Vollständige Mischer / Mitigeur
 complete / Mezclador completo

PR47HB102 **CRL**
IX, CRB, BLX, BRX, C03, C04, F31, F34
DOR, GOX, CHX, F32, F33, F36, F37

Accessori / Accessories / Zubehör / Accessoires / Accesorios

Ricambi / Spare parts / Ersatzteile / Pièces de rechange / Recambios

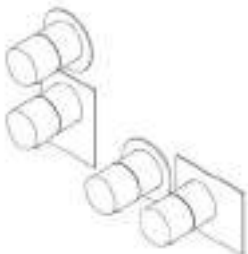
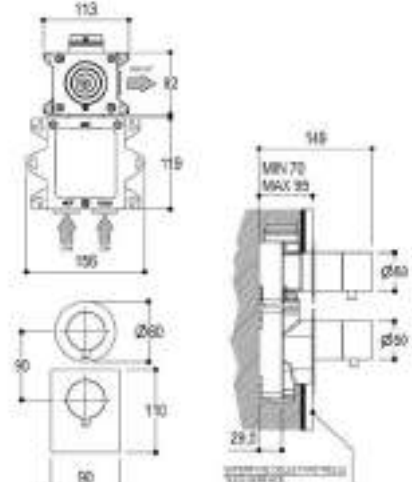

RCMB353 pag. 1219 RCMB828 pag. 1235 RCMB829 pag. 1235 RCMB833 pag. 1235 RCMB840 pag. 1235 RCMA004 pag. 1243

 <div style="display: flex; justify-content: space-around; margin-top: 10px;"> <div style="border: 1px solid black; padding: 2px; font-size: 8px;">IN 1/4"</div> <div style="border: 1px solid black; padding: 2px; font-size: 8px;">OUT 1/4"</div> </div>	<p>Miscelatore termostatico ad incasso <i>Built-in thermostatic mixer</i> <i>Thermostat UP-Mischer</i> <i>Mitigeur thermostatique à encastrer</i> <i>Mezclador termostático empotrado</i></p> <hr/> <p>_ regolatore di portata _ filtri e valvole di non ritorno _ una uscita _ completo di parti interne _ installabile in posizione verticale oppure orizzontale <i>_ flow regulator _ filters and non return valves _ one way _ with inner parts _ installation in both vertical and horizontal position</i> <i>_ Absperrung _ Filter und Rückschlagventil _ Ein Abgang _ mit UP-Teilen _ horizontal oder vertikal installierbar</i> <i>_ régulateur de débit _ filtres et soupapes de non retour _ une sortie _ avec parties internes _ possible installation en vertical ou horizontal</i> <i>_ regulador de caudal _ filtros y válvulas sin regreso _ una salida _ completo de partes internas _ instalación en posición horizontal o vertical</i></p>	
---	--	---

	<p>Parti esterne <i>Outer parts / Fertigset / Parties externes / Partes externas</i></p>	<p>PR47HC201 CRL IX, CRB, BLX, BRX, C03, C04, F31, F34 DOR, GOX, CHX, F32, F33, F36, F37</p>
---	--	---

	<p>Parti da incasso <i>Built-in parts / UP-teile / Parties internes / Partes internas</i></p>	<p>PM0030H</p>
--	---	-----------------------

<p>Miscelatore completo <i>Complete mixer / Vollständige Mischer / Mitigeur complete / Mezclador completo</i></p>	<p>PR47HB201 CRL IX, CRB, BLX, BRX, C03, C04, F31, F34 DOR, GOX, CHX, F32, F33, F36, F37</p>
---	---

Accessori / Accessories / Zubehör / Accessoires / Accesorios

Ricambi / Spare parts / Ersatzteile / Pièces de rechange / Recambios

						
RCMB353 pag. 1219	RCMB828 pag. 1235	RCMB829 pag. 1235	RCMB833 pag. 1235	RCMB840 pag. 1235	RCMB996 pag. 1243	RCMBA012 pag. 1244

POIS
 TIE
 TIP
 TAB
 REVERSO
 RITRÒ
 ELEMENTA ACCESSORI
 ELEMENTA IMPRONTE ACCESSORI
 ACCESSORI
 COMPLEMENTI WC
 PILETTE
 SIFONI DI SCARICO

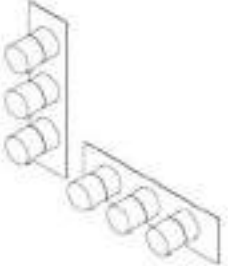

Miscelatore termostatico ad incasso
 Built-in thermostatic mixer
 UP-Thermostatmischer
 Mitigeur thermostatique à encastrer
 Mezclador termostático empotrado

_ regolatore di portata _ piastra esterna _ filtri e valvole di non ritorno _ due uscite indipendenti _ completo di parti interne _ installabile in posizione verticale oppure orizzontale
 _ flow regulator _ external plate _ filters and non return valves _ two separate exits _ with inner parts _ installation in both vertical and horizontal position
 _ Absperrung _ Montageplatte _ Filter und Rückschlagventil _ zwei separate Abgänge _ mit UP-Teilen _ horizontal oder vertikal installierbar
 _ régulateur de débit _ plaque externe _ filtres et soupapes de non retour _ deux sorties indépendantes _ avec parties internes _ possible installation en vertical ou horizontal
 _ regulador de caudal _ plancha externa _ filtros y válvulas sin regreso _ dos salidas independientes _ completo de partes internas _ instalación en posición horizontal o vertical

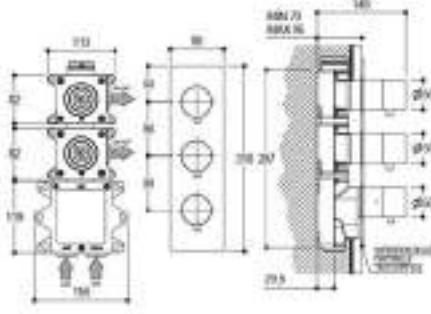

IN
3/4"

OUT
2x
3/4"



Parti esterne
 Outer parts / Fertigset / Parties externes / Partes externas

PR47HE101 **CRL**
IX, CRB, BLX, BRX, C03, C04, F31, F34
DOR, GOX, CHX, F32, F33, F36, F37



Parti da incasso
 Built-in parts / UP-teile / Parties internes / Partes internas

PM0030J

Miscelatore completo
 Complete mixer / Vollständige Mischer / Mitigeur complete / Mezclador completo

PR47HD101 **CRL**
IX, CRB, BLX, BRX, C03, C04, F31, F34
DOR, GOX, CHX, F32, F33, F36, F37

Accessori / Accessories / Zubehör / Accessoires / Accesorios

Ricambi / Spare parts / Ersatzteile / Pièces de rechange / Recambios

- | | | | | | |
|---|---|---|---|---|---|
|  |  |  |  |  |  |
| RCMB353
pag. 1219 | RCMB828
pag. 1235 | RCMB829
pag. 1235 | RCMB833
pag. 1235 | RCMB840
pag. 1235 | RCMBA005
pag. 1243 |

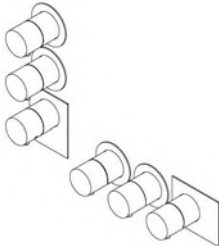

Miscelatore termostatico ad incasso
*Built-in thermostatic mixer
 UP-Thermostatmischer
 Mitigeur thermostatique à encastrer
 Mezclador termostático empotrado*

_ regolatore di portata _ filtri e valvole di non ritorno _ due uscite indipendenti _ completo di parti interne _ installabile in posizione verticale oppure orizzontale
*_ flow regulator _ filters and non return valves _ two separate exits _ with inner parts _ installation in both vertical and horizontal position
 Absperrung _ Filter und Rückschlagventil _ zwei separate Abgänge _ mit UP-Teilen _ horizontal oder vertikal installierbar
 _ régulateur de débit _ filtres et soupapes de non retour _ deux sorties indépendantes _ avec parties internes _ possible installation en vertical ou horizontal
 _ regulador de caudal _ filtros y válvulas sin regreso _ dos salidas independientes _ completo de partes internas _ instalación en posición horizontal o vertical*

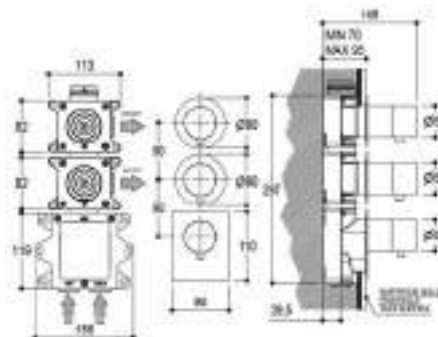

IN
3/4"

OUT
2x
3/4"



Parti esterne
Outer parts / Fertigset / Parties externes / Partes externas

PR47HE201

CRL
 IX, CRB, BLX, BRX, C03, C04, F31, F34
 DOR, GOX, CHX, F32, F33, F36, F37



Parti da incasso
Built-in parts / UP-teile / Parties internes / Partes internas

PM0030J

+

Miscelatore completo
Complete mixer / Vollständige Mischer / Mitigeur complete / Mezclador completo

PR47HD201

CRL
 IX, CRB, BLX, BRX, C03, C04, F31, F34
 DOR, GOX, CHX, F32, F33, F36, F37

||

Accessori / Accessories / Zubehör / Accessoires / Accesorios

Ricambi / Spare parts / Ersatzteile / Pièces de rechange / Recambios

- | | | | | | | |
|---|---|---|---|---|---|--|
|  |  |  |  |  |  |  |
| RCMB353
pag. 1219 | RCMB828
pag. 1235 | RCMB829
pag. 1235 | RCMB833
pag. 1235 | RCMB840
pag. 1235 | RCMB996
pag. 1243 | RCMBA012
pag. 1244 |

POIS
 TIE
 TIP
 TAB
 REVERSO
 RITRÒ
 ELEMENTA ACCESSORI
 ELEMENTA IMPRONTE ACCESSORI
 ACCESSORI
 COMPLEMENTI WC
 PILETTE
 SIFONI DI SCARICO

Miscelatore termostatico ad incasso
 Built-in thermostatic mixer
 UP-Thermostatmischer
 Mitigeur thermostatique à encastrer
 Mezclador termostático empotrado

_ regolatore di portata _ piastra esterna _ filtri e valvole di non ritorno _ tre uscite indipendenti _ completo di parti interne _ installabile in posizione verticale oppure orizzontale
 _ flow regulator _ external plate _ filters and non return valves _ three separate exits _ with inner parts _ installation in both vertical and horizontal position
 _ Absperrung _ Montageplatte _ Filter und Rückschlagventil _ drei separate Abgänge _ mit UP-Teilen _ horizontal oder vertikal installierbar
 _ régulateur de débit _ plaque externe _ filtres et soupapes de non retour _ trois sorties indépendantes _ avec parties internes _ possible installation en vertical ou horizontal
 _ regulador de caudal _ plancha externa _ filtros y válvulas sin regreso _ tres salidas independientes _ completo de partes internas _ instalación en posición horizontal o vertical



Parti esterne
 Outer parts / Fertigset / Parties externes / Partes externas

PR47HG102

CRL
 IX, CRB, BLX, BRX, C03, C04, F31, F34
 DOR, GOX, CHX, F32, F33, F36, F37



Parti da incasso
 Built-in parts / UP-teile / Parties internes / Partes internas

PM0030L

Miscelatore completo
 Complete mixer / Vollständige Mischer / Mitigeur complete / Mezclador completo

PR47HF102

CRL
 IX, CRB, BLX, BRX, C03, C04, F31, F34
 DOR, GOX, CHX, F32, F33, F36, F37

Accessori / Accessories / Zubehör / Accessoires / Accesorios

Ricambi / Spare parts / Ersatzteile / Pièces de rechange / Recambios



RCMB353 pag. 1219



RCMB828 pag. 1235



RCMB829 pag. 1235



RCMB833 pag. 1235



RCMB840 pag. 1235

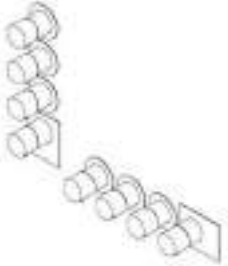
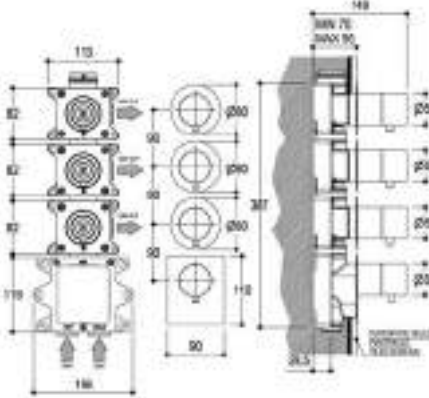

RCMBA006 pag. 1243

 <div data-bbox="199 549 309 606"> <p>IN 1/4" F OUT 3/4" F</p> </div>	<p>Miscelatore termostatico ad incasso <i>Built-in thermostatic mixer</i> <i>UP-Thermostatmischer</i> <i>Mitigeur thermostatique à encastrer</i> <i>Mezclador termostático empotrado</i></p> <hr/> <p>_ regolatore di portata _ filtri e valvole di non ritorno _ tre uscite indipendenti _ completo di parti interne _ installabile in posizione verticale oppure orizzontale <i>_ flow regulator _ filters and non return valves _ three separate exits _ with inner parts _ installation in both vertical and horizontal position</i> <i>_ Absperrung _ Filter und Rückschlagventil _ drei separate Abgänge _ mit UP-Teilen _ horizontal oder vertikal installierbar</i> <i>_ régulateur de débit _ filtres et soupapes de non retour _ trois sorties indépendantes _ avec parties internes _ possible installation en vertical ou horizontal</i> <i>_ regulador de caudal _ filtros y válvulas sin regreso _ tres salidas independientes _ completo de partes internas _ instalación en posición horizontal o vertical</i></p>	
--	--	---

	<p>Parti esterne <i>Outer parts / Fertigset / Parties externes / Partes externas</i></p>	<p>PR47HG201</p> <p>CRL <i>IX, CRB, BLX, BRX, C03, C04, F31, F34</i> <i>DOR, GOX, CHX, F32, F33, F36, F37</i></p>
---	--	---

	<p>Parti da incasso <i>Built-in parts / UP-teile / Parties internes / Partes internas</i></p>	<p>PM0030L</p>
--	---	-----------------------

<p>Miscelatore completo <i>Complete mixer / Vollständige Mischer / Mitigeur complete / Mezclador completo</i></p>	<p>PR47HF201</p>	<p>CRL <i>IX, CRB, BLX, BRX, C03, C04, F31, F34</i> <i>DOR, GOX, CHX, F32, F33, F36, F37</i></p>
---	-------------------------	---

Accessori / Accessories / Zubehör / Accessoires / Accesorios

Ricambi / Spare parts / Ersatzteile / Pièces de rechange / Recambios

 <p>RCMB353 pag. 1219</p>	 <p>RCMB828 pag. 1235</p>	 <p>RCMB829 pag. 1235</p>	 <p>RCMB833 pag. 1235</p>	 <p>RCMB840 pag. 1235</p>	 <p>RCMB996 pag. 1243</p>	 <p>RCMBA012 pag. 1244</p>
--	--	--	--	--	--	--



POIS
 TIE
 TIP
 TAB
 REVERSO
 RITRÒ
 ELEMENTA ACCESSORI
 ELEMENTA IMPRONTE ACCESSORI
 ACCESSORI
 COMPLEMENTI WC
 PILETTE
 SIFONI DI SCARICO

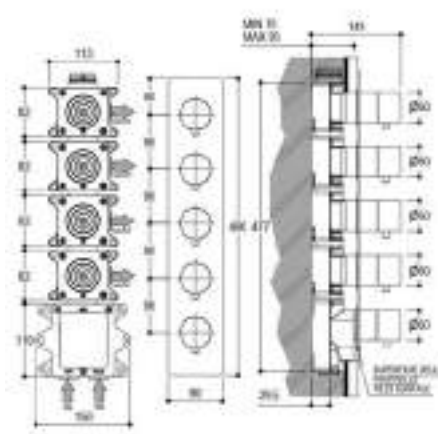

Miscelatore termostatico ad incasso
*Built-in thermostatic mixer
 UP-Thermostatmischer
 Mitigeur thermostatique à encastrer
 Mezclador termostático empotrado*

**_ regolatore di portata _ piastra esterna _ filtri e valvole di non ritorno
 _ quattro uscite indipendenti _ completo di parti interne _ installabile
 in posizione verticale oppure orizzontale**
*_ flow regulator _ external plate _ filters and non return valves _ four
 separate exits _ with inner parts _ installation in both vertical and horizontal
 position
 _ Absperrung _ Montageplatte _ Filter und Rückschlagventil _ vier separate
 Abgänge _ mit UP-Teilen _ horizontal oder vertikal installierbar
 _ régulateur de débit _ plaque externe _ filtres et soupapes de non retour _
 quatre sorties indépendantes _ avec parties internes _ possible installation en
 vertical ou horizontal
 _ regulador de caudal _ plancha externa _ filtros y válvulas sin regreso _
 cuatro salidas independientes _ completo de partes internas _ instalación en
 posición horizontal o vertical*





Parti esterne
*Outer parts / Fertigset / Parties externes / Partes
 externas*

PR47HJ101

CRL

IX, CRB, BLX, BRX, C03, C04, F31, F34

DOR, GOX, CHX, F32, F33, F36, F37



Parti da incasso
*Built-in parts / UP-teile / Parties internes / Partes
 internas*

PM0030M

+

Miscelatore completo
*Complete mixer / Vollständige Mischer / Mitigeur
 complete / Mezclador completo*

PR47HH101

CRL







IX, CRB, BLX, BRX, C03, C04, F31, F34

DOR, GOX, CHX, F32, F33, F36, F37

=

Accessori / Accessories / Zubehör / Accessoires / Accesorios

Ricambi / Spare parts / Ersatzteile / Pièces de rechange / Recambios

- | | | | | | |
|---|---|---|---|---|---|
|  |  |  |  |  |  |
| RCMB353
pag. 1219 | RCMB828
pag. 1235 | RCMB829
pag. 1235 | RCMB833
pag. 1235 | RCMB840
pag. 1235 | RCMBA007
pag. 1243 |

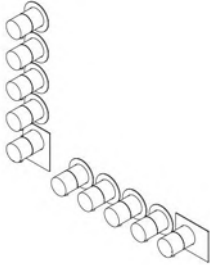
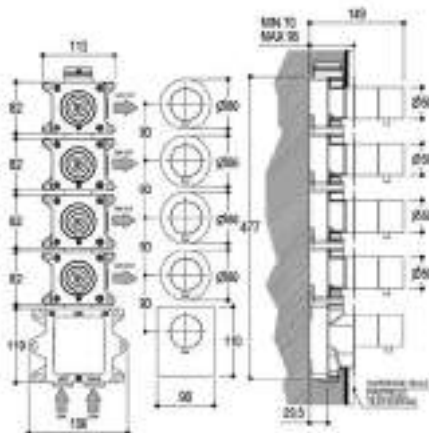
 <div data-bbox="199 549 309 606"> <p>IN 1/4" OUT 1/4"</p> </div>	<p>Miscelatore termostatico ad incasso <i>Built-in thermostatic mixer</i> <i>UP-Thermostatmischer</i> <i>Mitigeur thermostatique à encastrer</i> <i>Mezclador termostático empotrado</i></p> <p>_ regolatore di portata _ filtri e valvole di non ritorno _ quattro uscite indipendenti _ completo di parti interne _ installabile in posizione verticale oppure orizzontale <i>_ flow regulator _ filters and non return valves _ four separate exits _ with inner parts _ installation in both vertical and horizontal position</i> <i>Absperrung _ Filter und Rückschlagventil _ vier separate Abgänge _ mit UP-Teilen _ horizontal oder vertikal installierbar</i> <i>_ régulateur de débit _ filtres et soupapes de non retour _ quatre sorties indépendantes _ avec parties internes _ possible installation en vertical ou horizontal</i> <i>_ regulador de caudal _ filtros y válvulas sin regreso _ cuatro salidas independientes _ completo de partes internas _ instalación en posición horizontal o vertical</i></p>	
--	--	---

	<p>Parti esterne <i>Outer parts / Fertigset / Parties externes / Partes externas</i></p>	<p>PR47HJ201 CRL <i>IX, CRB, BLX, BRX, C03, C04, F31, F34</i> <i>DOR, GOX, CHX, F32, F33, F36, F37</i></p>
---	--	--

	<p>Parti da incasso <i>Built-in parts / UP-teile / Parties internes / Partes internas</i></p>	<p>PM0030M</p>
--	---	-----------------------

<p>Miscelatore completo <i>Complete mixer / Vollständige Mischer / Mitigeur complete / Mezclador completo</i></p>	<p>PR47HH201 CRL <i>IX, CRB, BLX, BRX, C03, C04, F31, F34</i> <i>DOR, GOX, CHX, F32, F33, F36, F37</i></p>
---	--

Accessori / Accessories / Zubehör / Accessoires / Accesorios

Ricambi / Spare parts / Ersatzteile / Pièces de rechange / Recambios

						
RCMB353 pag. 1219	RCMB828 pag. 1235	RCMB829 pag. 1235	RCMB833 pag. 1235	RCMB840 pag. 1235	RCMB996 pag. 1243	RCMBA012 pag. 1244

POIS
TIE
TIP
TAB
REVERSO
RITRÒ
ELEMENTA ACCESSORI
ELEMENTA IMPRONTE ACCESSORI
ACCESSORI
COMPLEMENTI WC
PILETTE
SIFONI DI SCARICO

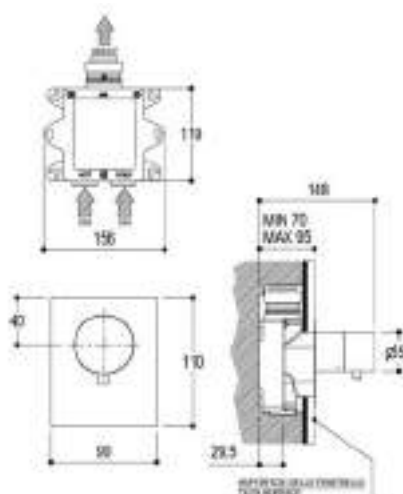

Miscelatore termostatico ad incasso
 Built-in thermostatic mixer
 UP-Thermostatmischer
 Mitigeur thermostatique à encastrer
 Mezclador termostático empotrado

_ piastra esterna _ regolazione di temperatura _ filtri e valvole di non ritorno _ una uscita _ completo di parti interne _ installabile in posizione verticale oppure orizzontale
 _ external plate _ temperature regulation _ filters and non return valves _ one way _ with inner parts _ installation in both vertical and horizontal position
 _ Montageplatte _ nur Temperaturregler _ Filter und Rückschlagventil _ Ein Abgang _ komplett mit UP-Teilen _ horizontal oder vertikal installierbar
 _ plaque externe _ réglage de température _ filtres et soupapes de non retour _ one sortie _ avec parties internes _ possible installation en vertical ou horizontal
 _ plancha externa _ regulación de temperatura _ filtros y válvulas sin regreso _ una salida _ completo de partes internas _ instalación en posición horizontal o vertical

IN **OUT**
 147 147



Parti esterne
 Outer parts / Fertigset / Parties externes / Partes externas

PR47HC101 **CRL**
IX, CRB, BLX, BRX, C03, C04, F31, F34
DOR, GOX, CHX, F32, F33, F36, F37



Parti da incasso
 Built-in parts / UP-teile / Parties internes / Partes internas

PM0030G

Miscelatore completo
 Complete mixer / Vollständige Mischer / Mitigeur complete / Mezclador completo

PR47HB101 **CRL**
IX, CRB, BLX, BRX, C03, C04, F31, F34
DOR, GOX, CHX, F32, F33, F36, F37

Accessori / Accessories / Zubehör / Accessoires / Accesorios

Ricambi / Spare parts / Ersatzteile / Pièces de rechange / Recambios



RCMB828 pag. 1235 RCMB833 pag. 1235 RCMB840 pag. 1235 RCMB996 pag. 1243

Per il corretto funzionamento l'articolo deve essere abbinato ad un rubinetto di arresto
 For proper working the item must be combined with a stop valve / Für den richtigen Betrieb muß der Artikel mit einem Unterputzabsperrventil kombiniert sein / Pour un fonctionnement correct l'article doit être jumelé avec un robinet d'arrêt / Para un funcionamiento correcto el articulo tiene que ser emparejado a una valvula de cierre

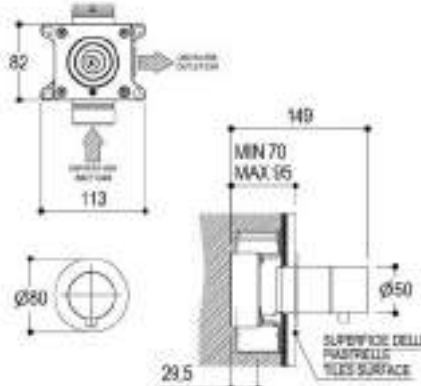
 <div data-bbox="199 549 309 604"> <p>IN 1/4" OUT 1/4"</p> </div>	<p>Rubinetto ad incasso <i>Built-in tap UP-Absperventil Robinet à encastrer Grifo empotrado</i></p> <hr/> <p>_ regolazione di portata _ vitone ceramico _ una uscita _ completo di parti interne <i>_ flow regulation _ ceramic disk cartridge _ one way _ with inner parts _ Ein Abgang _ keramikoberteil _ mit UP-Teilen _ réglage de débit _ une sortie _ tête céramique _ avec parties internes _ regulación de caudal _ cabeza con discos cerámicos _ una salida _ completo de partes internas</i></p>	
--	---	---

	<p>Parti esterne <i>Outer parts / Fertigset / Parties externes / Partes externas</i></p>	<p>PR47JB201 CRL IX, CRB, BLX, BRX, C03, C04, F31, F34 DOR, GOX, CHX, F32, F33, F36, F37</p>
---	--	---

	<p>Parti da incasso <i>Built-in parts / UP-teile / Parties internes / Partes internas</i></p>	<p>PM00404</p>
--	---	-----------------------

<p>Miscelatore completo <i>Complete mixer / Vollständige Mischer / Mitigeur complete / Mezclador completo</i></p>	<p>PR47JA201</p>	<p>CRL IX, CRB, BLX, BRX, C03, C04, F31, F34 DOR, GOX, CHX, F32, F33, F36, F37</p>
---	-------------------------	--

Accessori / Accessories / Zubehör / Accessoires / Accesorios

Ricambi / Spare parts / Ersatzteile / Pièces de rechange / Recambios

- | | | |
|---|---|---|
| 
RCMB353
pag. 1219 | 
RCMB829
pag. 1235 | 
RCMA012
pag. 1244 |
|---|---|---|

POIS
TIE
TIP
TAB
REVERSO
RITRÒ
ELEMENTA IMPRONTE ACCESSORI
ACCESSORI
COMPLEMENTI WC
PILETTE
SIFONI DI SCARICO

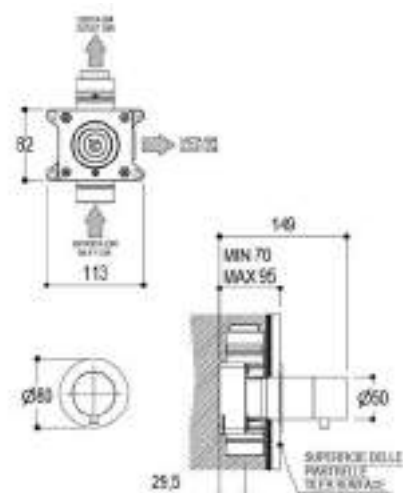

Rubinetto di arresto anche per installazione in serie
Built-in stop valve connectable in series
UP-Absperrventil auch für Serieninstallation
Robinet d'arrêt a encastrer aussi pour l'installation en série
Valvula de cierre tambien para instalaciòn en serie

_ 1 ingresso _ 1 uscita laterale comandata da vitone ceramico con posizione di stop e regolazione di portata _ 1 uscita superiore sempre aperta per alimentazione in serie _ completo di parti interne
_ 1 inlet _ 1 lateral way controllabile by ceramic headwork with stop position and flow regulator _ 1 upper way constantly open for connection in series _ with inner parts
_ 1 Zutritt _ 1 Seitenabgang bei einem Keramikoberteil bedient mit Stoppsposition und Durchflussmengeregelung _ 1 Obere Abgang immer geöffnet für Seriensorgung _ mit UP-Teilen
_ 1 entrée _ 1 sortie latérale commandée par une tête céramique avec position de stop et régulation du débit _ 1 sortie supérieure toujours ouverte pour alimentation en série _ complet de parties internes
_ 1 entrada _ 1 salida lateral mandada para una cabeza con discos cerámicos con posición de stop y regulador de caudal _ 1 salida superior siempre abierta para alimentación en serie _ completa de partes internas

IN 1/4" **OUT** 2x 3/4"



Parti esterne
Outer parts / Fertigset / Parties externes / Partes externas

PR47JB201 **CRL**
IX, CRB, BLX, BRX, C03, C04, F31, F34
DOR, GOX, CHX, F32, F33, F36, F37



Parti da incasso
Built-in parts / UP-teile / Parties internes / Partes internas

PM00405

Miscelatore completo
Complete mixer / Vollständige Mischer / Mitigeur complete / Mezclador completo

PR47JA202 **CRL**
IX, CRB, BLX, BRX, C03, C04, F31, F34
DOR, GOX, CHX, F32, F33, F36, F37

Accessori / Accessories / Zubehör / Accessoires / Accesorios

Ricambi / Spare parts / Ersatzteile / Pièces de rechange / Recambios

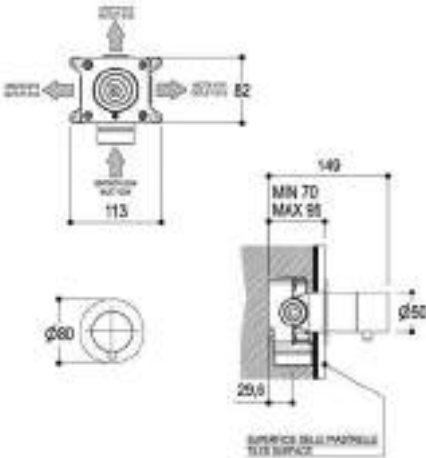

RCMB353 pag. 1219
RCMB829 pag. 1235
RCMBA012 pag. 1244

 <div data-bbox="194 549 309 604"> <p>IN 3/4"</p> <p>OUT 1/2"</p> </div>	<p>Deviatore ad incasso con regolazione portata <i>Built-in diverter with flow regulator</i> <i>UP-Umstellung mit Absperrung</i> <i>Inverseur à encastrer avec régulateur de débit</i> <i>Desviador empotrado con regulador de potencia</i></p> <hr/> <p>_tre uscite: vasca-doccetta-soffione con posizioni di stop intermedie _ completo di parti interne <i>_ three ways out: bath-hand shower-head shower with intermediate stop positions _ with inner parts</i> <i>Dreiweg-Umsteller: Badewanne-Dusche-Kopfbrause mit Zwischenhaltpositionen _ mit UP-Teilen</i> <i>_ trois sorties: baignoire-douchette-tête de douche avec positions de stop intermédiaires _ avec parties internes</i> <i>_ tres salidas: bañera-ducha teléfono-rociador con posiciones de stop intermedias _ completo de partes internas</i></p>	
---	---	---

	<p>Parti esterne <i>Outer parts / Fertigset / Parties externes / Partes externas</i></p>	<p>PR47LB201 CRL <i>IX, CRB, BLX, BRX, C03, C04, F31, F34</i> <i>DOR, GOX, CHX, F32, F33, F36, F37</i></p>
---	--	--

	<p>Parti da incasso <i>Built-in parts / UP-teile / Parties internes / Partes internas</i></p>	<p>PM00706</p>
--	---	-----------------------

<p>Miscelatore completo <i>Complete mixer / Vollständige Mischer / Mitigeur complete / Mezclador completo</i></p>	<p>PR47LA201 CRL <i>IX, CRB, BLX, BRX, C03, C04, F31, F34</i> <i>DOR, GOX, CHX, F32, F33, F36, F37</i></p>
---	--

Accessori / Accessories / Zubehör / Accessoires / Accesorios

Ricambi / Spare parts / Ersatzteile / Pièces de rechange / Recambios

 <p>RCMB829 pag. 1235</p>	 <p>RCMB909 pag. 1240</p>	 <p>RCMB954 pag. 1241</p>	 <p>RCMBA013 pag. 1244</p>
--	--	--	---

POIS
TIE
TIP
TAB
REVERSO
RITRÒ
ELEMENTA ACCESSORI
ELEMENTA IMPRONTE ACCESSORI
ACCESSORI
COMPLEMENTI WC
PILETTE
SIFONI DI SCARICO

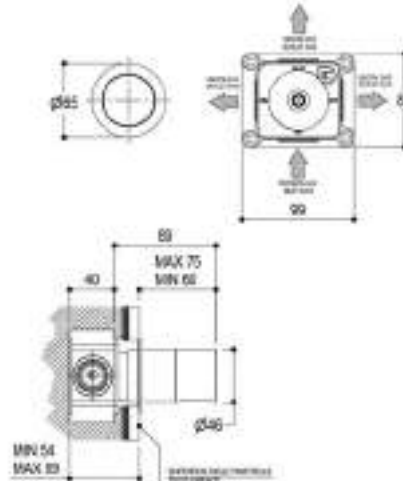
 <div style="display: flex; justify-content: space-between; margin-top: 10px;"> <div style="border: 1px solid black; padding: 2px;">IN 1/2"</div> <div style="border: 1px solid black; padding: 2px;">OUT 1/2"</div> </div>	<p>Deviatore ad incasso <i>Built-in diverter UP-Umstellung Inverseur à encastrer Desviador empotrado</i></p> <hr/> <p>tre uscite: vasca-doccetta-soffione e posizione di stop _ completo di parti interne <i>_ three ways: bath-hand shower-head shower and stop position _ with inner parts _ drei Abgänge: Wanne-Brause-Wandanschlußbogen und Stopstellung _ mit UP-Teilen _ trois sorties: baignoire-douchette-bras de douche et stop _ avec parties internes _ tres salidas: bañera-duchita-pomo ducha y stop _ completo de partes internas</i></p>	
--	---	---

	<p>Parti esterne <i>Outer parts / Fertigset / Parties externes / Partes externas</i></p>	<p>PR47LB221</p>	<p>CRL IX, CRB, BLX, BRX, C03, C04, F31, F34 DOR, GOX, CHX, F32, F33, F36, F37</p>
---	--	-------------------------	---



	<p>Parti da incasso <i>Built-in parts / UP-teile / Parties internes / Partes internas</i></p>	<p>PM00707</p>	<p style="text-align: right;">+</p>
--	---	-----------------------	-------------------------------------

<p>Miscelatore completo <i>Complete mixer / Vollständige Mischer / Mitigeur complete / Mezclador completo</i></p>	<p>PR47LA221</p>	<p>CRL IX, CRB, BLX, BRX, C03, C04, F31, F34 DOR, GOX, CHX, F32, F33, F36, F37</p>	<p style="text-align: right;">=</p>
---	-------------------------	---	-------------------------------------

Accessori / Accessories / Zubehör / Accessoires / Accesorios

Ricambi / Spare parts / Ersatzteile / Pièces de rechange / Recambios

				
RCMB199 pag. 1217	RCMB462H1 pag. 1220	RCMB898 pag. 1239	RCMB954 pag. 1241	RCMBA129 pag. 1248

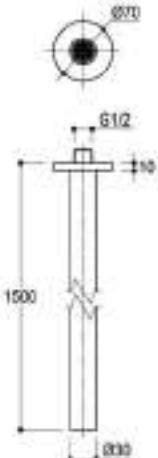
  	<p>Bocca di erogazione da soffitto per lavabo <i>Washbasin ceiling mounted spout</i> <i>Waschbecken Deckenauslauf</i> <i>Bec de lavabo suspendu</i> <i>Caño salida a techo por lavabo</i></p> <hr/> <p>L=1500mm _ L=1500mm _ L=1500mm _ L=1500mm _ L=1500mm</p>	
---	---	---

E0BA0185H03



CRL
 IX, CRB, BLX, BRX, C03, C04, F31, F34
 DOR, GOX, CHX, F32, F33, F36, F37

Accessori / Accessories / Zubehör / Accessoires / Accesorios

Ricambi / Spare parts / Ersatzteile / Pièces de rechange / Recambios

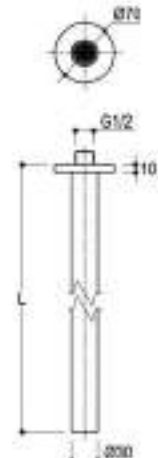

RCMB507
 pag. 1221

  	<p>Bocca di erogazione da soffitto per lavabo <i>Washbasin ceiling mounted spout</i> <i>Waschbecken Deckenauslauf</i> <i>Bec de lavabo suspendu</i> <i>Caño salida a techo por lavabo</i></p> <hr/> <p>Lunghezza (L) personalizzabile su richiesta: minimo 500mm, massimo 1600mm _ Customizable length (L) on application, min 500mm max 1600mm _ Länge (L) auf Wunsch min 500mm max 1600mm _ Longueur (L) personnalisable sur demande min 500mm max 1600mm _ Largo (L) personalizable sobre solicitud min 500 max 1600mm</p>	
---	---	---

E0BA0185H--

CRL
 IX, CRB, BLX, BRX, C03, C04, F31, F34
 DOR, GOX, CHX, F32, F33, F36, F37

Accessori / Accessories / Zubehör / Accessoires / Accesorios

Ricambi / Spare parts / Ersatzteile / Pièces de rechange / Recambios



RCMB507
 pag. 1221

POIS

TIE

TIP

TAB

REVERSO

RITRÒ

ELEMENTA ACCESSORI

ELEMENTA IMPRONTE ACCESSORI

ACCESSORI

COMPLEMENTI WC

PILETTE

SIFONI DI SCARICO

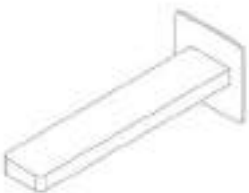

Bocca di erogazione da muro per vasca
Wall spout for bathtub
Wandauslauf für Badewanne
Bec verseur à mur pour baignoire
Caño a muro para bañera

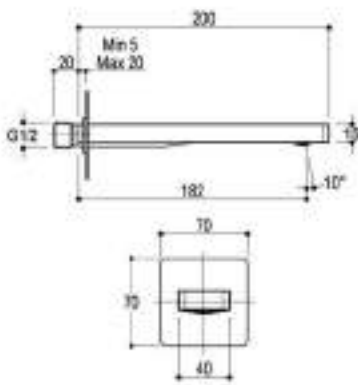

IN
1/2" M

PR31CC201 **CRL**
IX, CRB, BLX, BRX, C03, C04, F31, F34
DOR, GOX, CHX, F32, F33, F36, F37

Accessori / Accessories / Zubehör / Accessoires / Accesorios

Ricambi / Spare parts / Ersatzteile / Pièces de rechange / Recambios



RCMB512 pag. 1221 RCMB522 pag. 1222 RCMB718 pag. 1230



Miscelatore monocomando
Single lever mixer
Einhandmischer
Mitigeur monocommande
Mezclador monomando

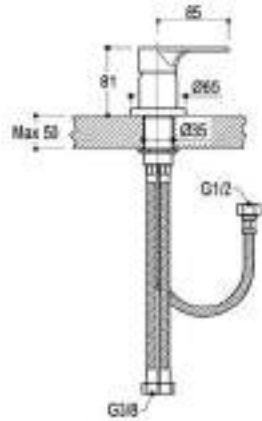

IN
3/8"

OUT
1/2"

IN
3/8"

PR31AW201 **CRL**
IX, CRB, BLX, BRX, C03, C04, F31, F34
DOR, GOX, CHX, F32, F33, F36, F37

Accessori / Accessories / Zubehör / Accessoires / Accesorios

Ricambi / Spare parts / Ersatzteile / Pièces de rechange / Recambios

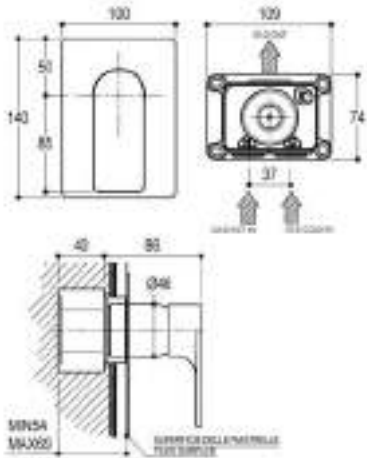

RCMB015 pag. 1213 RCMB021 pag. 1214 RCMB125 pag. 1217 RCMB505 pag. 1221 RCMB742 pag. 1231

 <div data-bbox="194 549 309 604" style="display: flex; gap: 5px;"> <div style="border: 1px solid black; padding: 2px;">IN 1/2"</div> <div style="border: 1px solid black; padding: 2px;">OUT 1/2"</div> </div>	<p>Miscelatore monocomando ad incasso per doccia/lavabo <i>Built-in single lever shower/basin mixer</i> <i>UP-Einhandmischer für Dusche/Waschtisch</i> <i>Mitigeur monocommande à encastrer pour douche/lavabo</i> <i>Mezclador monomando empotrado para ducha/lavabo</i></p> <hr/> <p>_ piastra esterna _ una uscita _ completo di parti interne <i>_ external plate _ one way _ complete of inner parts</i> <i>_ Montageplatte _ Ein Abgang _ komplett mit UP-Teilen</i> <i>_ plaque externe _ une sortie _ complet avec parties internes</i> <i>_ plancha externa _ una salida _ completo de partes internas</i></p>	
---	---	---

	<p>Parti esterne <i>Outer parts / Fertigset / Parties externes / Partes externas</i></p>	<p>PR31FC101 CRL <i>IX, CRB, BLX, BRX, C03, C04, F31, F34</i> <i>DOR, GOX, CHX, F32, F33, F36, F37</i></p>
---	--	--

	<p>Parti da incasso <i>Built-in parts / UP-teile / Parties internes / Partes internas</i></p>	<p>E0BA0143</p>
--	---	------------------------

<p>Miscelatore completo <i>Complete mixer / Vollständige Mischer / Mitigeur complete / Mezclador completo</i></p>	<p>PR31FB101 CRL <i>IX, CRB, BLX, BRX, C03, C04, F31, F34</i> <i>DOR, GOX, CHX, F32, F33, F36, F37</i></p>
---	--

Accessori / Accessories / Zubehör / Accessoires / Accesorios

Prolunghe / Extensions / Verlängerungen / Rallonges / Prolongadoras & Ricambi / Spare parts / Ersatzteile / Pièces de rechange / Recambios

					
+20mm RCMB054H1 pag. 1202	+40mm RCMB054H2 pag. 1202	RCMB015 pag. 1213	RCMB505 pag. 1221	RCMB508 pag. 1221	RCMB742 pag. 1231

POIS
TIE
TIP
TAB
REVERSO
RITRÒ
ELEMENTA ACCESSORI
ELEMENTA IMPRONTE ACCESSORI
ACCESSORI
COMPLEMENTI WC
PILETTI
SIFONI DI SCARICO

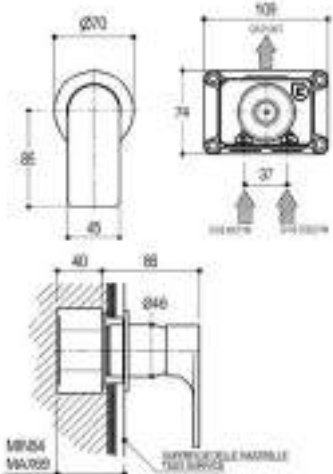
 <div data-bbox="88 549 204 609"> <p>IN 1/2"</p> <p>OUT 1/2"</p> </div>	<p>Miscelatore monocomando ad incasso per doccia/lavabo <i>Built-in single lever shower/basin mixer</i> <i>UP-Einhandmischer für Dusche/Waschtisch</i> <i>Mitigeur monocommande à encastrer pour douche/lavabo</i> <i>Mezclador monomando empotrado para ducha/lavabo</i></p> <hr/> <p>_ una uscita _ completo di parti interne <i>_ one way _ complete of inner parts</i> <i>_ Ein Abgang _ komplett mit UP-Teilen</i> <i>_ une sortie _ complet avec parties internes</i> <i>_ una salida _ completo de partes internas</i></p>	
--	---	---

	<p>Parti esterne <i>Outer parts / Fertigset / Parties externes / Partes externas</i></p>	<p>PR31FC201 CRL</p> <hr/> <p>IX, CRB, BLX, BRX, C03, C04, F31, F34</p> <hr/> <p>DOR, GOX, CHX, F32, F33, F36, F37</p>
---	--	---

	<p>Parti da incasso <i>Built-in parts / UP-teile / Parties internes / Partes internas</i></p>	<p>E0BA0143</p>
--	---	------------------------

<p>Miscelatore completo <i>Complete mixer / Vollständige Mischer / Mitigeur complete / Mezclador completo</i></p>	<p>PR31FB201 CRL</p> <hr/> <p>IX, CRB, BLX, BRX, C03, C04, F31, F34</p> <hr/> <p>DOR, GOX, CHX, F32, F33, F36, F37</p>
---	---

Accessori / Accessories / Zubehör / Accessoires / Accesorios

Prolunghe / Extensions / Verlängerungen / Rallonges / Prolongadoras & Ricambi / Spare parts / Ersatzteile / Pièces de rechange / Recambios

					
+20mm RCMB054H1 pag. 1202	+40mm RCMB054H2 pag. 1202	RCMB015 pag. 1213	RCMB462H1 pag. 1220	RCMB505 pag. 1221	RCMB742 pag. 1231