

## Tie

**Finiture disponibili / Available finishings / Erhältliche Oberflächen / Finitions disponibles / Acabados disponibles :**

<b>CRL</b>	CROMO / CHROME / CHROME / CHROME / CROMO
<b>IX</b>	SPAZZOLATO / BRUSHED / GEBÜRSTETEM / BROSSÉ / CEPILLADO
<b>CRB</b>	BLACK CHROME
<b>BLX</b>	BRUSHED BLACK CHROME

<b>MISCELATORI PER LAVABO</b>
BASIN MIXERS
MISCHER FÜR WASCHTISCH
MITIGEURS POUR LAVABO
MEZCLADORES PARA LAVABO



PR34AA101 pag. 830    PR34AA201 pag. 830    PR34AA202 pag. 831    PR34AF201 pag. 831    PR34AH101 pag. 832    PR34AH201 pag. 833    PR34AH102 pag. 834    PR34AH202 pag. 835

<b>MISCELATORI PER BIDET</b>
BIDET MIXERS
MISCHER FÜR BIDET
MITIGEURS POUR BIDET
MEZCLADORES PARA BIDET



PR34BA101 pag. 836    PR34BA201 pag. 836

<b>GRUPPI VASCA</b>
BATH GROUPS
MISCHBATTERIE FÜR BADEWANNE
MITIGEURS POUR BAIGNOIRE
GRUPOS PARA BAÑERA



PR34EA201 pag. 837    PR34EH201 pag. 837    PR34EB101 pag. 838

<b>GRUPPI DOCCIA</b>
SHOWER GROUPS
MISCHBATTERIE FÜR DUSCHE
MITIGEURS POUR DOUCHE
GRUPOS PARA DUCHA

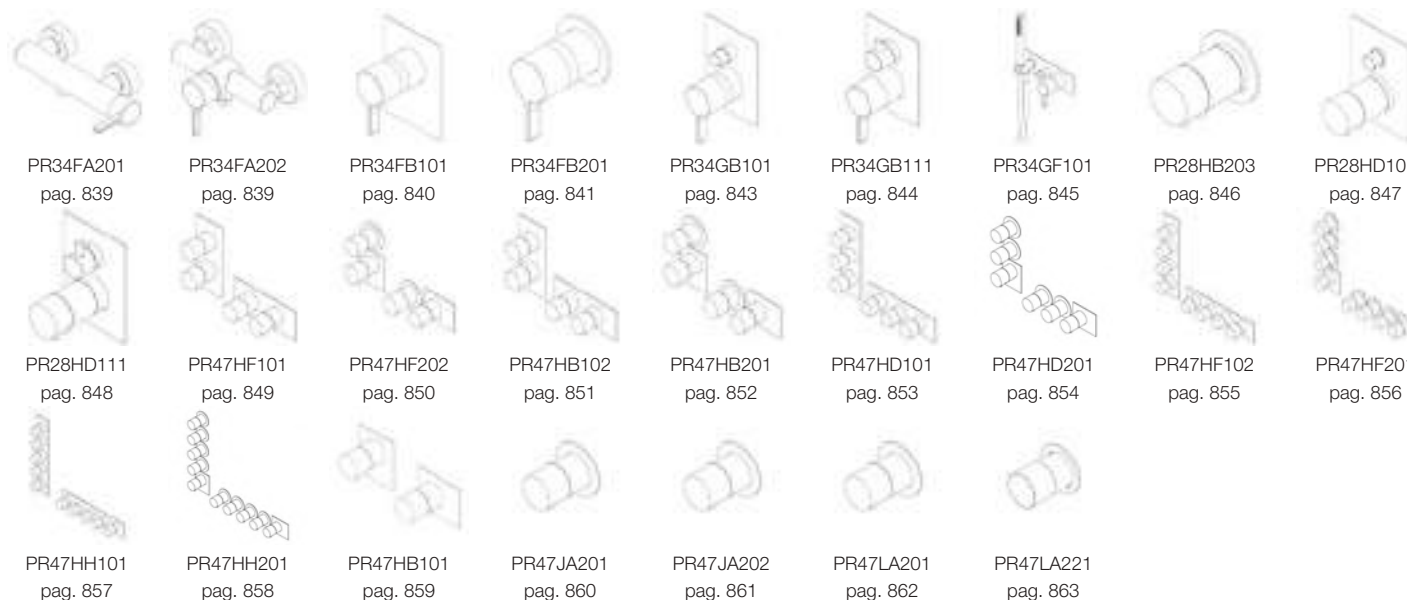

PR34FA201 pag. 839    PR34FA202 pag. 839    PR34FB101 pag. 840    PR34FB201 pag. 841    PR34GB101 pag. 843    PR34GB111 pag. 844    PR34GF101 pag. 845    PR28HB203 pag. 846    PR28HD101 pag. 847

PR28HD111 pag. 848    PR47HF101 pag. 849    PR47HF202 pag. 850    PR47HB102 pag. 851    PR47HB201 pag. 852    PR47HD101 pag. 853    PR47HD201 pag. 854    PR47HF102 pag. 855    PR47HF201 pag. 856

PR47HH101 pag. 857    PR47HH201 pag. 858    PR47HB101 pag. 859    PR47JA201 pag. 860    PR47JA202 pag. 861    PR47LA201 pag. 862    PR47LA221 pag. 863

<b>BOCCHIE DI EROGAZIONE</b>
SPOUTS
WANDAUSLÄUFE
BECS VERSEURS
CAÑOS



E0BA0185H03  
pag. 864



E0BA0185H--  
pag. 864



PR34CC201  
pag. 865

<b>COMANDI REMOTI</b>
MIXERS
MISCHER
MITIGEURS
MEZCLADORES



PR34AW201  
pag. 865



PR34FB101  
pag. 866



PR34FB201  
pag. 867

POIS

TIE

TIP

TAB

REVERSO

RITRÒ

ELEMENTA  
ACCESSORI

ELEMENTA  
IMPRONTE  
ACCESSORI

ACCESSORI

COMPLEMENTI  
WC

PILETTE

SIFONI DI  
SCARICO



**Miscelatore monocomando per lavabo**  
*Single lever basin mixer  
 Waschtisch Einhandmischer  
 Mitigeur monocommande pour lavabo  
 Mezclador monomando para lavabo*





**PR34AA101** **CRL**  
**IX, CRB, BLX**

Accessori / Accessories / Zubehör / Accessoires / Accesorios

Prolunghe / Extensions / Verlängerungen / Rallonges / Prolongadoras & Ricambi / Spare parts / Ersatzteile / Pièces de rechange / Recambios

								
PR34AA901 pag. 1201	PR34AA902 pag. 1201	RCMB068 pag. 1216	RCMB316 pag. 1218	RCMB435 pag. 1220	RCMB507 pag. 1221	RCMB584 pag. 1224	RCMB612 pag. 1225	RCMB613 pag. 1226

**Disponibile sia in versione Eco che Ecoplus, per miscelatore Ecoplus aggiungere E dopo la finitura (es: PR43AU101CRL --> PR43AU101CRLE)**  
 Available in both versions: Eco and Ecoplus, for Ecoplus mixer add E after finishing code (ex: PR43AU101CRL --> PR43AU101CRLE) / Sowohl Version Eco als auch Ecoplus verfügbar, für Ecoplus Mischer bitte nach der Oberfläche den Buchstabe E hinzufügen (z. B. PR43AU101CRL --> PR43AU101CRLE) / Disponible en deux versions: Eco et Ecoplus, pour mitigeur Ecoplus ajouter E après la finition (ex: PR43AU101CRL --> PR43AU101CRLE) / Disponible en versión Eco y Ecoplus, para mezclador Ecoplus añadir E después el acabado (es: PR43AU101CRL --> PR43AU101CRLE)



**Miscelatore monocomando per lavabo**  
*Single lever basin mixer  
 Waschtisch Einhandmischer  
 Mitigeur monocommande pour lavabo  
 Mezclador monomando para lavabo*





**PR34AA201** **CRL**  
**IX, CRB, BLX**

Accessori / Accessories / Zubehör / Accessoires / Accesorios

Prolunghe / Extensions / Verlängerungen / Rallonges / Prolongadoras & Ricambi / Spare parts / Ersatzteile / Pièces de rechange / Recambios



							
PR34AA901 pag. 1201	PR34AA902 pag. 1201	RCMB068 pag. 1216	RCMB435 pag. 1220	RCMB507 pag. 1221	RCMB584 pag. 1224	RCMB612 pag. 1225	RCMB613 pag. 1226

**Disponibile sia in versione Eco che Ecoplus, per miscelatore Ecoplus aggiungere E dopo la finitura (es: PR43AU101CRL --> PR43AU101CRLE)**  
 Available in both versions: Eco and Ecoplus, for Ecoplus mixer add E after finishing code (ex: PR43AU101CRL --> PR43AU101CRLE) / Sowohl Version Eco als auch Ecoplus verfügbar, für Ecoplus Mischer bitte nach der Oberfläche den Buchstabe E hinzufügen (z. B. PR43AU101CRL --> PR43AU101CRLE) / Disponible en deux versions: Eco et Ecoplus, pour mitigeur Ecoplus ajouter E après la finition (ex: PR43AU101CRL --> PR43AU101CRLE) / Disponible en versión Eco y Ecoplus, para mezclador Ecoplus añadir E después el acabado (es: PR43AU101CRL --> PR43AU101CRLE)

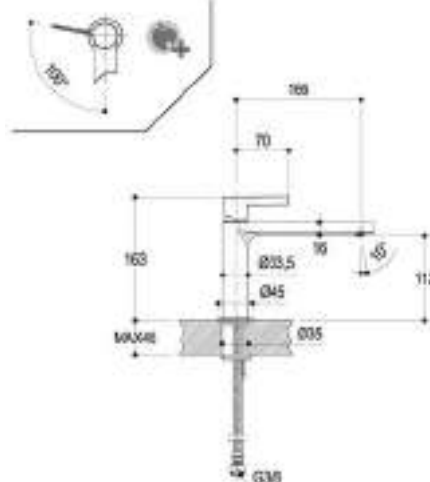

**Miscelatore monocomando per lavabo**  
*Single lever basin mixer*  
*Waschtisch Einhandmischer*  
*Mitigeur monocommande pour lavabo*  
*Mezclador monomando para lavabo*



**PR34AA202**    **CRL**  
**IX, CRB, BLX**

Accessori / Accessories / Zubehör / Accessoires / Accesorios

Prolunghe / Extensions / Verlängerungen / Rallonges / Prolongadoras & Ricambi / Spare parts / Ersatzteile / Pièces de rechange / Recambios



- |   |   |   |   |   |   |   |   |
|---|---|---|---|---|---|---|---|
|  |  |  |  |  |  |  |  |
| PR34AA901<br>pag. 1201  | PR34AA902<br>pag. 1201  | RCMB068<br>pag. 1216  | RCMB435<br>pag. 1220  | RCMB507<br>pag. 1221  | RCMB584<br>pag. 1224  | RCMB612<br>pag. 1225  | RCMB613<br>pag. 1226  |

**Disponibile sia in versione Eco che Ecoplus, per miscelatore Ecoplus aggiungere E dopo la finitura (es: PR43AU101CRL --> PR43AU101CRLE)**  
 Available in both versions: Eco and Ecoplus, for Ecoplus mixer add E after finishing code (ex: PR43AU101CRL --> PR43AU101CRLE) / Sowohl Version Eco als auch Ecoplus verfügbar, für Ecoplus Mischer bitte nach der Oberfläche den Buchstabe E hinzufügen (z. B. PR43AU101CRL --> PR43AU101CRLE) / Disponible en deux versions: Eco et Ecoplus, pour mitigeur Ecoplus ajouter E après la finition (ex: PR43AU101CRL --> PR43AU101CRLE) / Disponible en versión Eco y Ecoplus, para mezclador Ecoplus añadir E después el acabado (es: PR43AU101CRL --> PR43AU101CRLE)

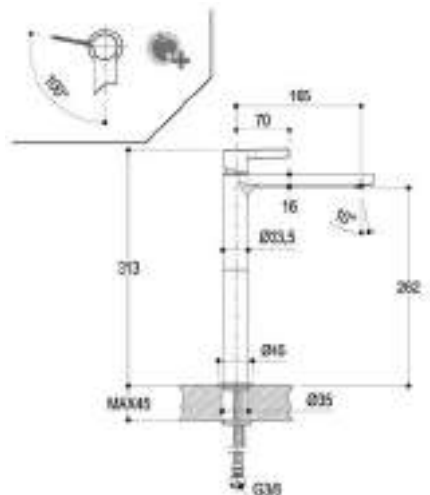

**Miscelatore monocomando soprapiano per lavabo**  
*Exposed single lever basin mixer*  
*Waschtisch Standmischbatterie*  
*Mitigeur monocommande sur-plan pour lavabo*  
*Mezclador monomando sobre encimera*



**PR34AF201**    **CRL**  
**IX, CRB, BLX**

Accessori / Accessories / Zubehör / Accessoires / Accesorios

Ricambi / Spare parts / Ersatzteile / Pièces de rechange / Recambios

- |   |   |   |   |   |   |
|---|---|---|---|---|---|
|  |  |  |  |  |  |
| RCMB435<br>pag. 1220  | RCMB507<br>pag. 1221  | RCMB515<br>pag. 1222  | RCMB584<br>pag. 1224  | RCMB612<br>pag. 1225  | RCMB613<br>pag. 1226  |

**Disponibile sia in versione Eco che Ecoplus, per miscelatore Ecoplus aggiungere E dopo la finitura (es: PR43AU101CRL --> PR43AU101CRLE)**  
 Available in both versions: Eco and Ecoplus, for Ecoplus mixer add E after finishing code (ex: PR43AU101CRL --> PR43AU101CRLE) / Sowohl Version Eco als auch Ecoplus verfügbar, für Ecoplus Mischer bitte nach der Oberfläche den Buchstabe E hinzufügen (z. B. PR43AU101CRL --> PR43AU101CRLE) / Disponible en deux versions: Eco et Ecoplus, pour mitigeur Ecoplus ajouter E après la finition (ex: PR43AU101CRL --> PR43AU101CRLE) / Disponible en versión Eco y Ecoplus, para mezclador Ecoplus añadir E después el acabado (es: PR43AU101CRL --> PR43AU101CRLE)

POIS

TIE

TIP

TAB

REVERSO

RITRÒ

ELEMENTA ACCESSORI

ELEMENTA IMPRONTA ACCESSORI

ACCESSORI

COMPLEMENTI WC

PILETTE

SIFONI DI SCARICO

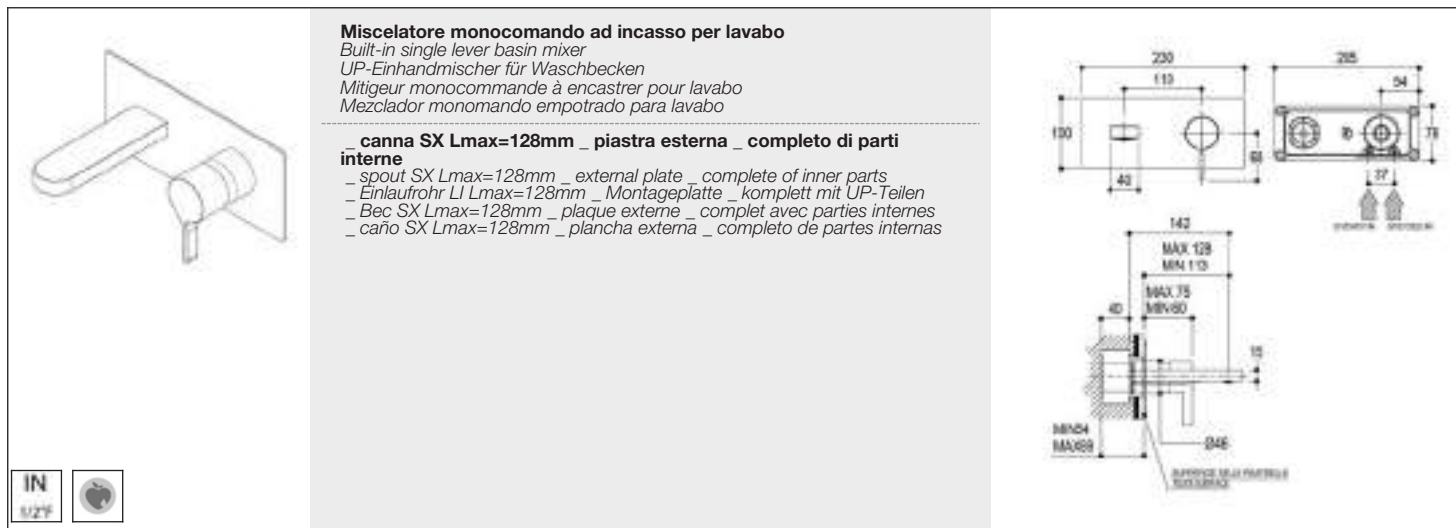

**Miscelatore monocomando ad incasso per lavabo**  
 Built-in single lever basin mixer  
 UP-Einhandmischer für Waschbecken  
 Mitigeur monocommande à encastrer pour lavabo  
 Mezclador monomando empotrado para lavabo

**\_ canna SX Lmax=128mm \_ piastra esterna \_ completo di parti interne**  
 \_ spout SX Lmax=128mm \_ external plate \_ complete of inner parts  
 \_ Einlaufrohr LI Lmax=128mm \_ Montageplatte \_ komplett mit UP-Teilen  
 \_ Bec SX Lmax=128mm \_ plaque externe \_ complet avec parties internes  
 \_ caño SX Lmax=128mm \_ plancha externa \_ completo de partes internas

**IN** 



**Parti esterne**  
 Outer parts / Fertigset / Parties externes / Partes externas

**PR34AL101** **CRL**  
 IX, CRB, BLX



**Parti da incasso**  
 Built-in parts / UP-teile / Parties internes / Partes internas

**E0BA0115SX**

**Miscelatore completo**  
 Complete mixer / Vollständige Mischer / Mitigeur complete / Mezclador completo

**PR34AH101** **CRL**  
 IX, CRB, BLX

Accessori / Accessories / Zubehör / Accessoires / Accesorios

Prolunghe / Extensions / Verlängerungen / Rallonges / Prolongadoras & Ricambi / Spare parts / Ersatzteile / Pièces de rechange / Recambios



**+20mm** RCMB054H1 pag. 1202

**+40mm** RCMB054H2 pag. 1202

RCMB015 pag. 1213

RCMB507 pag. 1221

RCMB510 pag. 1221

RCMB585 pag. 1224

RCMB593 pag. 1225

RCMB742 pag. 1231

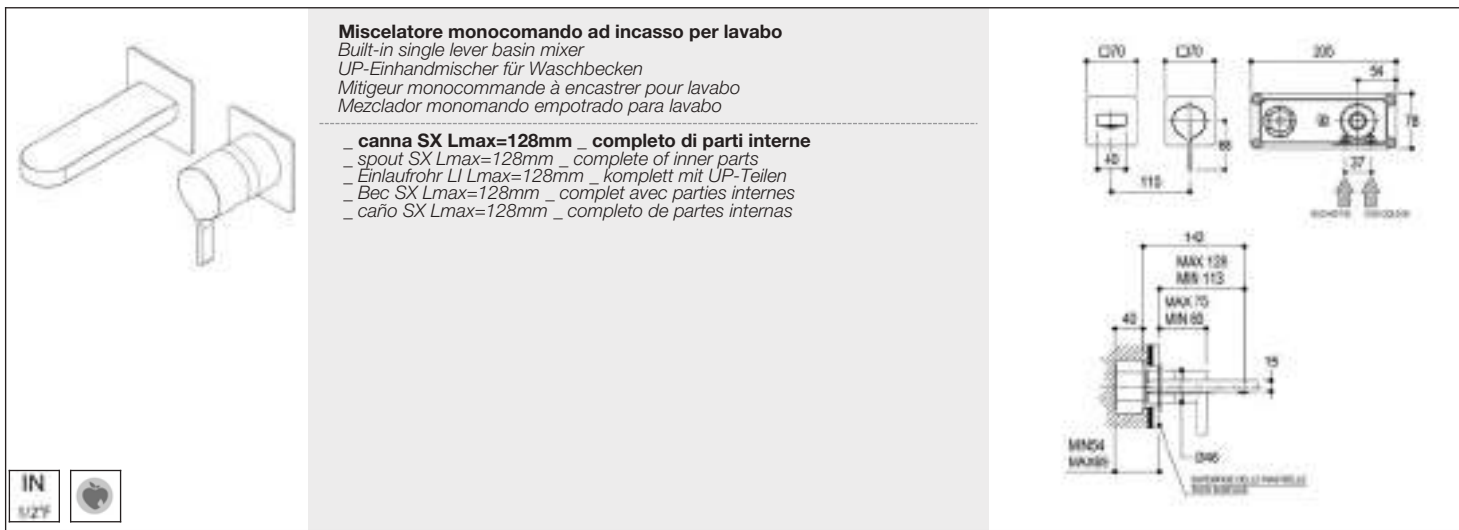

**Miscelatore monocomando ad incasso per lavabo**  
 Built-in single lever basin mixer  
 UP-Einhandmischer für Waschbecken  
 Mitigeur monocommande à encastrer pour lavabo  
 Mezclador monomando empotrado para lavabo

— canna SX Lmax=128mm \_ completo di parti interne  
 — spout SX Lmax=128mm \_ complete of inner parts  
 — Einlaufrohr LJ Lmax=128mm \_ komplett mit UP-Teilen  
 — Bec SX Lmax=128mm \_ complet avec parties internes  
 — caño SX Lmax=128mm \_ completo de partes internas

IN  
 UZF



**Parti esterne**  
 Outer parts / Fertigset / Parties externes / Partes externas

**PR34AL201** **CRL**  
 IX, CRB, BLX



**Parti da incasso**  
 Built-in parts / UP-teile / Parties internes / Partes internas

**E0BA0115SX**

**Miscelatore completo**  
 Complete mixer / Vollständige Mischer / Mitigeur complete / Mezclador completo

**PR34AH201** **CRL**  
 IX, CRB, BLX

Accessori / Accessories / Zubehör / Accessoires / Accesorios

Prolunghe / Extensions / Verlängerungen / Rallonges / Prolongadoras & Ricambi / Spare parts / Ersatzteile / Pièces de rechange / Recambios



+20mm  
 RCMB054H1 pag. 1202

+40mm  
 RCMB054H2 pag. 1202

RCMB015 pag. 1213

RCMB507 pag. 1221

RCMB511 pag. 1221

RCMB512 pag. 1221

RCMB585 pag. 1224

RCMB593 pag. 1225

RCMB742 pag. 1231

POIS  
 TIE  
 TIP  
 TAB  
 REVERSO  
 RITRÒ  
 ELEMENTA ACCESSORI  
 ELEMENTA IMPRONTE ACCESSORI  
 ACCESSORI  
 COMPLEMENTI WC  
 PILETTE  
 SIFONI DI SCARICO

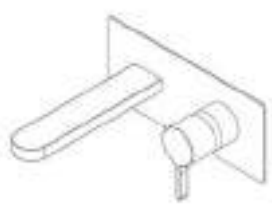



**Miscelatore monocomando ad incasso per lavabo**  
*Built-in single lever basin mixer*  
*UP-Einhandmischer für Waschbecken*  
*Mitigeur monocommande à encastrer pour lavabo*  
*Mezclador monomando empotrado para lavabo*

---

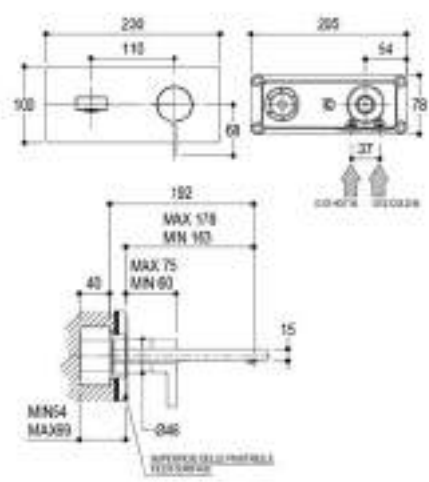
**\_ canna SX Lmax=178mm \_ piastra esterna \_ completo di parti interne**  
*\_ spout SX Lmax=178mm \_ external plate \_ complete of inner parts*  
*\_ Einlaufrohr LI Lmax=178mm \_ Montageplatte \_ komplett mit UP-Teilen*  
*\_ Bec SX Lmax=178mm \_ plaque externe \_ complet avec parties internes*  
*\_ caño SX Lmax=178mm \_ plancha externa \_ completo de partes internas*







**Parti esterne**  
*Outer parts / Fertigset / Parties externes / Partes externas*

**PR34AL102**

**CRL**  
**IX, CRB, BLX**

+



**Parti da incasso**  
*Built-in parts / UP-teile / Parties internes / Partes internas*

**E0BA0115SX**

=

**Miscelatore completo**  
*Complete mixer / Vollständige Mischer / Mitigeur complete / Mezclador completo*

**PR34AH102**

**CRL**  
**IX, CRB, BLX**

**Accessori / Accessories / Zubehör / Accessoires / Accesorios**

**Prolunghe / Extensions / Verlängerungen / Rallonges / Prolongadoras & Ricambi / Spare parts / Ersatzteile / Pièces de rechange / Recambios**



+20mm  
RCMB054H1  
pag. 1202



+40mm  
RCMB054H2  
pag. 1202



RCMB015  
pag. 1213



RCMB507  
pag. 1221



RCMB510  
pag. 1221



RCMB585  
pag. 1224



RCMB594  
pag. 1225



RCMB742  
pag. 1231

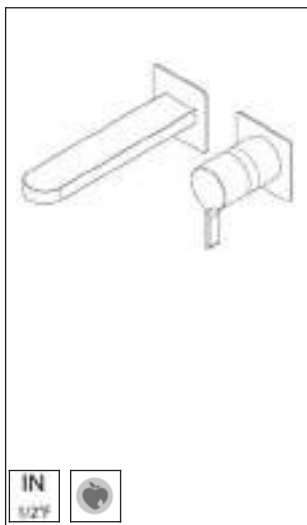
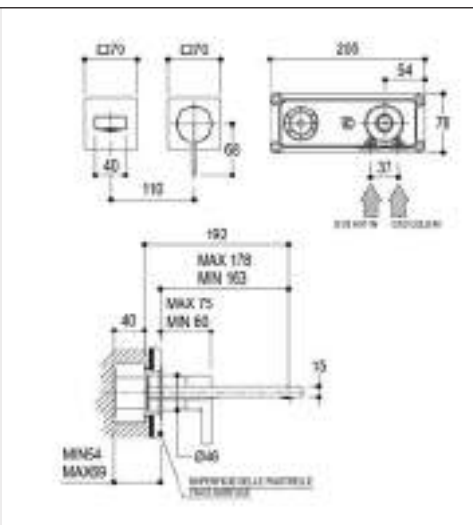

	<p><b>Miscelatore monocomando ad incasso per lavabo</b>  <i>Built-in single lever basin mixer</i>  <i>UP-Einhandmischer für Waschbecken</i>  <i>Mitigeur monocommande à encastrer pour lavabo</i>  <i>Mezclador monomando empotrado para lavabo</i></p> <hr/> <p><b>_ canna SX Lmax=178mm _ completo di parti interne</b>  <i>_ spout SX Lmax=178mm _ complete of inner parts</i>  <i>_ Einlaufrohr LJ Lmax=178mm _ komplett mit UP-Teilen</i>  <i>_ Bec SX Lmax=178mm _ complet avec parties internes</i>  <i>_ caño SX Lmax=178mm _ completo de partes internas</i></p>	
--	---	--

	<p><b>Parti esterne</b>  <i>Outer parts / Fertigset / Parties externes / Partes externas</i></p>	<p><b>PR34AL202</b> <b>CRL</b>  <b>IX, CRB, BLX</b></p>
---	--	---

	<p><b>Parti da incasso</b>  <i>Built-in parts / UP-teile / Parties internes / Partes internas</i></p>	<p><b>E0BA0115SX</b></p>
--	---	--------------------------

<p><b>Miscelatore completo</b>  <i>Complete mixer / Vollständige Mischer / Mitigeur complete / Mezclador completo</i></p>	<p><b>PR34AH202</b> <b>CRL</b>  <b>IX, CRB, BLX</b></p>
---	---

Accessori / Accessories / Zubehör / Accessoires / Accesorios

Prolunghe / Extensions / Verlängerungen / Rallonges / Prolongadoras & Ricambi / Spare parts / Ersatzteile / Pièces de rechange / Recambios



 <p><b>+20mm</b> RCMB054H1 pag. 1202</p>	 <p><b>+40mm</b> RCMB054H2 pag. 1202</p>	 <p>RCMB015 pag. 1213</p>	 <p>RCMB507 pag. 1221</p>	 <p>RCMB511 pag. 1221</p>	 <p>RCMB512 pag. 1221</p>	 <p>RCMB585 pag. 1224</p>	 <p>RCMB594 pag. 1225</p>	 <p>RCMB742 pag. 1231</p>
---	---	--	--	--	--	--	---	--

POIS  
TIE  
TIP  
TAB  
REVERSO  
RITRÒ  
ELEMENTA ACCESSORI  
ELEMENTA IMPRONTE ACCESSORI  
ACCESSORI  
COMPLEMENTI WC  
PILETTI  
SIFONI DI SCARICO

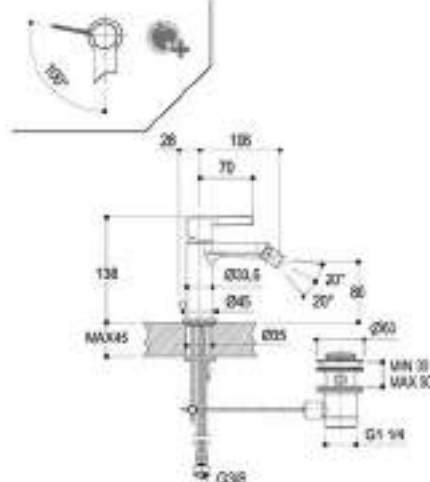

**Miscelatore monocomando per bidet**  
*Single lever bidet mixer*  
*Einhandbidetmischer*  
*Mitigeur monocommande pour bidet*  
*Mezclador monomando para bidet*



**PR34BA101**

**CRL**  
**IX, CRB, BLX**

Accessori / Accessories / Zubehör / Accessoires / Accesorios

Prolunghe / Extensions / Verlängerungen / Rallonges / Prolongadoras & Ricambi / Spare parts / Ersatzteile / Pièces de rechange / Recambios



									
PR34AA901 pag. 1201	PR34AA902 pag. 1201	RCMB019 pag. 1214	RCMB068 pag. 1216	RCMB316 pag. 1218	RCMB435 pag. 1220	RCMB476 pag. 1220	RCMB584 pag. 1224	RCMB612 pag. 1225	RCMB613 pag. 1226

**Disponibile sia in versione Eco che Ecoplus, per miscelatore Ecoplus aggiungere E dopo la finitura (es: PR43AU101CRL --> PR43AU101CRLE)**  
 Available in both versions: Eco and Ecoplus, for Ecoplus mixer add E after finishing code (ex: PR43AU101CRL --> PR43AU101CRLE) / Sowohl Version Eco als auch Ecoplus verfügbar, für Ecoplus Mischer bitte nach der Oberfläche den Buchstabe E hinzufügen (z. B. PR43AU101CRL --> PR43AU101CRLE) / Disponible en deux versions: Eco et Ecoplus, pour mitigeur Ecoplus ajouter E après la finition (ex: PR43AU101CRL --> PR43AU101CRLE) / Disponible en versión Eco y Ecoplus, para mezclador Ecoplus añadir E después el acabado (es: PR43AU101CRL --> PR43AU101CRLE)

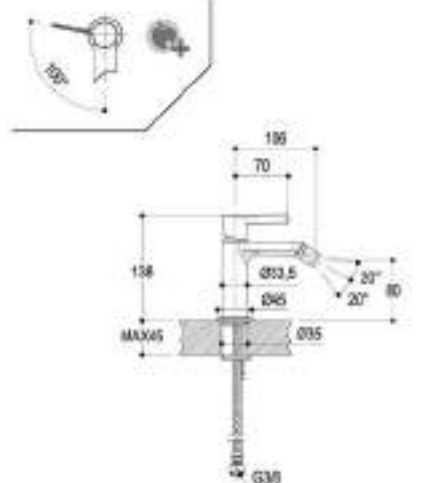

**Miscelatore monocomando per bidet**  
*Single lever bidet mixer*  
*Einhandbidetmischer*  
*Mitigeur monocommande pour bidet*  
*Mezclador monomando para bidet*



**PR34BA201**

**CRL**  
**IX, CRB, BLX**

Accessori / Accessories / Zubehör / Accessoires / Accesorios

Prolunghe / Extensions / Verlängerungen / Rallonges / Prolongadoras & Ricambi / Spare parts / Ersatzteile / Pièces de rechange / Recambios

								
PR34AA901 pag. 1201	PR34AA902 pag. 1201	RCMB019 pag. 1214	RCMB068 pag. 1216	RCMB435 pag. 1220	RCMB476 pag. 1220	RCMB584 pag. 1224	RCMB612 pag. 1225	RCMB613 pag. 1226

**Disponibile sia in versione Eco che Ecoplus, per miscelatore Ecoplus aggiungere E dopo la finitura (es: PR43AU101CRL --> PR43AU101CRLE)**  
 Available in both versions: Eco and Ecoplus, for Ecoplus mixer add E after finishing code (ex: PR43AU101CRL --> PR43AU101CRLE) / Sowohl Version Eco als auch Ecoplus verfügbar, für Ecoplus Mischer bitte nach der Oberfläche den Buchstabe E hinzufügen (z. B. PR43AU101CRL --> PR43AU101CRLE) / Disponible en deux versions: Eco et Ecoplus, pour mitigeur Ecoplus ajouter E après la finition (ex: PR43AU101CRL --> PR43AU101CRLE) / Disponible en versión Eco y Ecoplus, para mezclador Ecoplus añadir E después el acabado (es: PR43AU101CRL --> PR43AU101CRLE)

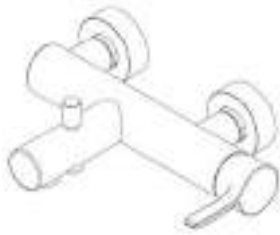

**Miscelatore monocomando esterno per vasca**  
*External single lever bath mixer*  
*AP- Einhandmischer für Badewanne*  
*Mitigeur monocommande externe pour baignoire*  
*Mezclador monomando externo para bañera*

---

**\_ due uscite \_ deviatore automatico vasca/doccia**  
*\_ two ways \_ automatic diverter bath/shower*  
*\_ zwei Abgänge \_ automatische Umstellung von Wanne auf Dusche*  
*\_ deux sorties \_ inverseur automatique bain/douche*  
*\_ dos salidas \_ desviador automático bañera/ducha*

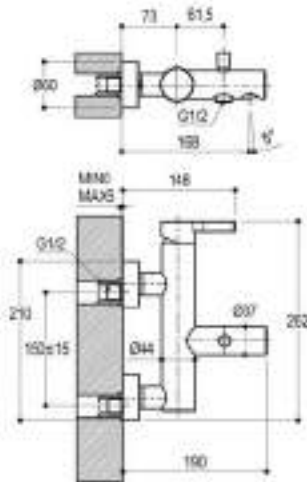

**IN** 1/2" M

**OUT** 1/2" M

**PR34EA201**    **CRL**  
**IX, CRB, BLX**

Accessori / Accessories / Zubehör / Accessoires / Accesorios

Ricambi / Spare parts / Ersatzteile / Pièces de rechange / Recambios

				
RCMB007H1 pag. 1213	RCMB114 pag. 1216	RCMB321 pag. 1219	RCMB586 pag. 1224	RCMB651 pag. 1228



**Miscelatore monocomando esterno per vasca**  
*External single lever bath mixer*  
*AP- Einhandmischer für Badewanne*  
*Mitigeur monocommande externe pour baignoire*  
*Mezclador monomando externo para bañera*

---

**\_ due uscite \_ deviatore automatico vasca/doccia \_ doccia Ø24mm in ottone con flessibile da 1500mm \_ getto fisso**  
*\_ two ways \_ automatic diverter bath/shower \_ Ø24mm brass hand shower with 1500mm flexible hose \_ fixed jet*  
*\_ zwei Abgänge \_ automatische Umstellung von Wanne auf Dusche \_ Handbrause Ø24mm aus Messing mit Schlauch 1500mm \_ feststehender Strahl*  
*\_ deux sorties \_ inverseur automatique bain/douche \_ douchette Ø24mm en laiton avec flexible de 1500mm \_ jet fixe*  
*\_ dos salidas \_ desviador automático bañera/ducha \_ ducha teléfono Ø24mm en latón con flexible de 1500mm \_ chorro fijo*

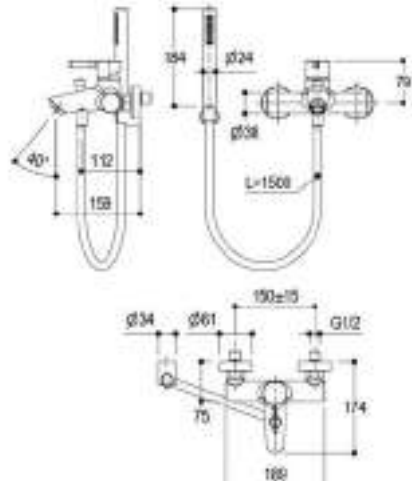

**IN** 1/2" M

**PR34EH201**    **CRL**

Accessori / Accessories / Zubehör / Accessoires / Accesorios

Ricambi / Spare parts / Ersatzteile / Pièces de rechange / Recambios

			
RCMB321 pag. 1219	RCMB566 pag. 1223	RCMB567 pag. 1224	RCMB586 pag. 1224

POIS  
 TIE  
 TIP  
 TAB  
 REVERSO  
 RITRÒ  
 ELEMENTA ACCESSORI  
 ELEMENTA IMPRONTA ACCESSORI  
 ACCESSORI  
 COMPLEMENTI WC  
 PILETTE  
 SIFONI DI SCARICO



**Miscelatore monocomando ad incasso per vasca**  
*Built-in single lever bath mixer*  
*Einhandmischer für Badewanne*  
*Mitigeur monocommande à encastrer pour baignoire*  
*Mezclador monomando empotrado para bañera*

---

**\_ miscelatore monocomando a due uscite con deviatore automatico**  
**bocca di erogazione/doccetta \_ bocca di erogazione L=182mm \_**  
**doccetta Ø24mm in ottone con flessibile da 1500mm \_ completo di**  
**parti interne**  
*\_ single lever mixer with two outlets with automatic diverter spout/hand*  
*shower \_ spout L=182mm \_ Ø24mm brass hand shower with 1500mm*  
*flexible hose \_ complete of inner parts*  
*\_ zwei Abgänge Einhandmischer mit automatischem Umsteller*  
*Auslauf/Brause \_ Wandauslauf L=182mm \_ Handbrause Ø24mm aus*  
*messing mit Schlauch 1500mm \_ komplett mit UP-Teilen*  
*\_ deux sorties mitigeur monocommande avec inverseur automatique*  
*bec/douchette \_ bec verseur L=182mm \_ douchette Ø24mm en laiton avec*  
*flexible de 1500mm \_ complet avec parties internes*  
*\_ mezclador monomando dos salidas con desviador automático*  
*caño/duchita \_ caño L=182mm \_ ducha teléfono Ø24mm en latón con*  
*flexible de 1500mm \_ completo de partes internas*

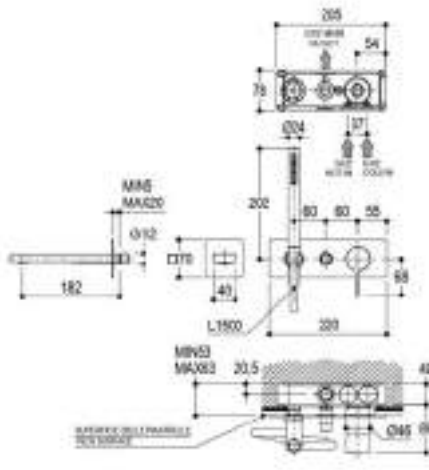

IN  
2x1/2"

OUT  
1/2"



**Parti esterne**  
*Outer parts / Fertigset / Parties externes / Partes*  
*externas*

**PR34EC101**

**CRL**  
**IX, CRB, BLX**

+



**Parti da incasso**  
*Built-in parts / UP-teile / Parties internes / Partes*  
*internas*

**PM0020D**

=

**Miscelatore completo**  
*Complete mixer / Vollständige Mischer / Mitigeur*  
*complete / Mezclador completo*

**PR34EB101**

**CRL**  
**IX, CRB, BLX**

Accessori / Accessories / Zubehör / Accessoires / Accesorios

Prolunghe / Extensions / Verlängerungen / Rallonges / Prolongadoras & Ricambi / Spare parts / Ersatzteile / Pièces de rechange / Recambios

- |  |   |   |   |   |   |   |  |   |   |   |
|--|---|---|---|---|---|---|--|---|---|---|
|  |  |  |  |  |  |  |  |  |  |  |
| RCMB521H1<br>pag. 1203   | RCMB521H2<br>pag. 1203  | RCMB015<br>pag. 1213  | RCMB035<br>pag. 1214  | RCMB512<br>pag. 1221  | RCMB519<br>pag. 1222  | RCMB522<br>pag. 1222  | RCMB526<br>pag. 1222   | RCMB585<br>pag. 1224  | RCMB719<br>pag. 1230  | RCMB742<br>pag. 1231  |

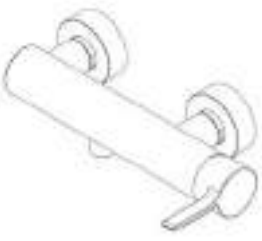

**Miscelatore monocomando esterno per doccia**  
*External single lever shower mixer*  
*AP- Einhandmischer für Dusche*  
*Mitigeur monocommande externe pour douche*  
*Mezclador monomando externo para ducha*

---

\_ una uscita  
 \_ one way  
 \_ Ein Abgang  
 \_ une sortie  
 \_ una salida

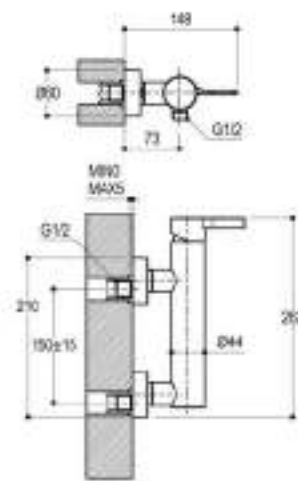

**IN**  
1/2" M

**OUT**  
1/2" M

**PR34FA201** CRL  
IX, CRB, BLX

Accessori / Accessories / Zubehör / Accessoires / Accesorios

Ricambi / Spare parts / Ersatzteile / Pièces de rechange / Recambios



RCMB007H1  
pag. 1213



RCMB586  
pag. 1224



RCMB651  
pag. 1228



**Miscelatore monocomando esterno per doccia**  
*External single lever shower mixer*  
*AP- Einhandmischer für Dusche*  
*Mitigeur monocommande externe pour douche*  
*Mezclador monomando externo para ducha*

---

\_ una uscita  
 \_ one way  
 \_ Ein Abgang  
 \_ une sortie  
 \_ una salida

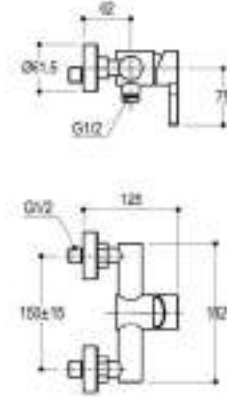

**IN**  
1/2" M

**OUT**  
1/2" M

**PR34FA202** CRL

Accessori / Accessories / Zubehör / Accessoires / Accesorios

Ricambi / Spare parts / Ersatzteile / Pièces de rechange / Recambios



RCMB586  
pag. 1224



RCMB778  
pag. 1232

POIS

TIE

TIP

TAB

REVERSO

RITRÒ

ELEMENTA ACCESSORI

ELEMENTA IMPRONTE ACCESSORI

ACCESSORI

COMPLEMENTI WC

PILETTE

SIFONI DI SCARICO

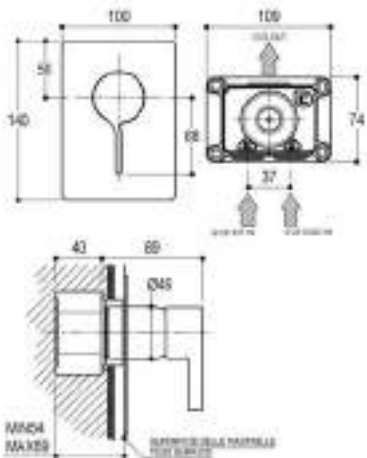
 <div data-bbox="88 549 204 602"> <p><b>IN</b> 1/2"</p> <p><b>OUT</b> 1/2"</p> </div>	<p><b>Miscelatore monocomando ad incasso per doccia/lavabo</b>  <i>Built-in single lever shower/basin mixer</i>  <i>UP-Einhandmischer für Dusche/Waschtisch</i>  <i>Mitigeur monocommande à encastrer pour douche/lavabo</i>  <i>Mezclador monomando empotrado para ducha/lavabo</i></p> <hr/> <p><b>_ piastra esterna _ una uscita _ completo di parti interne</b>  <i>_ external plate _ one way _ complete of inner parts</i>  <i>_ Montageplatte _ Ein Abgang _ komplett mit UP-Teilen</i>  <i>_ plaque externe _ une sortie _ complet avec parties internes</i>  <i>_ plancha externa _ una salida _ completo de partes internas</i></p>	
--	---	---

	<p><b>Parti esterne</b>  <i>Outer parts / Fertigset / Parties externes / Partes externas</i></p>	<p><b>PR34FC101</b></p>	<p><b>CRL</b>  <b>IX, CRB, BLX</b></p>
---	--	-------------------------	--







	<p><b>Parti da incasso</b>  <i>Built-in parts / UP-teile / Parties internes / Partes internas</i></p>	<p><b>E0BA0143</b></p>	
--	---	------------------------	--





<p><b>Miscelatore completo</b>  <i>Complete mixer / Vollständige Mischer / Mitigeur complete / Mezclador completo</i></p>	<p><b>PR34FB101</b></p> <p><b>CRL</b>  <b>IX, CRB, BLX</b></p>
---	--

Accessori / Accessories / Zubehör / Accessoires / Accesorios

Prolunghe / Extensions / Verlängerungen / Rallonges / Prolongadoras & Ricambi / Spare parts / Ersatzteile / Pièces de rechange / Recambios

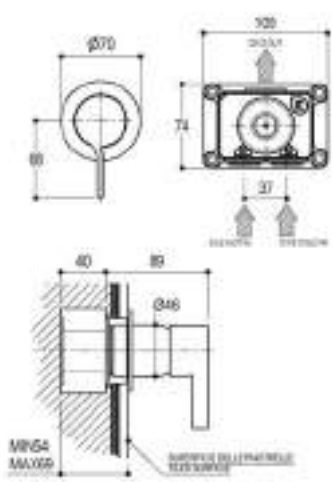
 <p><b>+20mm</b></p>	 <p><b>+40mm</b></p>				
RCMB054H1 pag. 1202	RCMB054H2 pag. 1202	RCMB015 pag. 1213	RCMB508 pag. 1221	RCMB585 pag. 1224	RCMB742 pag. 1231

 <div data-bbox="199 549 309 604"> <p>IN 1/2" OUT 1/2"</p> </div>	<p><b>Miscelatore monocomando ad incasso per doccia/lavabo</b>  <i>Built-in single lever shower/basin mixer</i>  <i>UP-Einhandmischer für Dusche/Waschtisch</i>  <i>Mitigeur monocommande à encastrer pour douche/lavabo</i>  <i>Mezclador monomando empotrado para ducha/lavabo</i></p> <hr/> <p><b>_ una uscita _ completo di parti interne</b>  <i>_ one way _ complete of inner parts</i>  <i>_ Ein Abgang _ komplett mit UP-Teilen</i>  <i>_ une sortie _ complet avec parties internes</i>  <i>_ una salida _ completo de partes internas</i></p>	
--	---	---

	<p><b>Parti esterne</b>  <i>Outer parts / Fertigset / Parties externes / Partes externas</i></p>	<p><b>PR34FC201</b> <b>CRL</b>  <b>IX, CRB, BLX</b></p>
+		
	<p><b>Parti da incasso</b>  <i>Built-in parts / UP-teile / Parties internes / Partes internas</i></p>	<p><b>E0BA0143</b></p>
=		
<p><b>Miscelatore completo</b>  <i>Complete mixer / Vollständige Mischer / Mitigeur complete / Mezclador completo</i></p>		<p><b>PR34FB201</b> <b>CRL</b>  <b>IX, CRB, BLX</b></p>

Accessori / Accessories / Zubehör / Accessoires / Accesorios

Prolunghe / Extensions / Verlängerungen / Rallonges / Prolongadoras & Ricambi / Spare parts / Ersatzteile / Pièces de rechange / Recambios

					
<b>+20mm</b> RCMB054H1 pag. 1202	<b>+40mm</b> RCMB054H2 pag. 1202	RCMB015 pag. 1213	RCMB462H1 pag. 1220	RCMB585 pag. 1224	RCMB742 pag. 1231

POIS  
TIE  
TIP  
TAB  
REVERSO  
RITRÒ  
ELEMENTA ACCESSORI  
ELEMENTA IMPRONTE ACCESSORI  
ACCESSORI  
COMPLEMENTI WC  
PILETTE  
SIFONI DI SCARICO





**Staffa verticale di fissaggio per miscelatore incasso doppio**  
 Fixing brackets for double shower mixer for vertical installation  
 Vertikale Montagehalterung für UP-Doppel-Mischer  
 Support de fixation pour double mitigeur de douche à encastrer en vertical  
 Soporte de montaje para mezclador empotrado vertical doble

per ·Diametro35\_0139SP-0140(S/P) ·Diametro35\_Impronte-PR51 ·  
**FM101-FM201 ·Diametro35\_S-PR52 ·FB101-FB201-LA221**  
 ·Diametro35\_Cross-PR53 ·FB101-FB201 ·Diametro35\_Elegance-PR54 ·  
**FB101-FB201 ·Diametro35\_Inox\_0139SP-0140(S/P)**  
 ·Diametro35\_Inox\_Concrete\_0139SP-0140(S/P) ·Reverso ·6040(S/P)  
 ·Pois-PR31 ·FB101-FB201 ·Glitter-PR32 ·FB101-FB201 ·Tie-PR34 ·  
**FB101-FB201 ·Taormina-PR35 ·LA221 ·Tab-PR37 ·FB101-FB201 ·Tip-PR38 ·**  
**FB101-FB201 ·Haptic-PR43 ·FM101-FM201-LA221 ·DOT316-PR50 ·**  
**Tip-PR38 ·FB101-FB201 ·Haptic-PR43 ·FM101-FM201-LA221**  
 ·DOT316-PR50 ·FB111-FB201-FB211-FB221-LA221  
 ·Comandi\_Wellness-PR28 ·HB203-HB204-HB205  
 ·Comandi\_Wellness-PR47 ·LA221-LA231  
 for ·Diametro35\_0139SP-0140(S/P) ·Diametro35\_Impronte-PR51 ·  
 FM101-FM201 ·Diametro35\_S-PR52 ·FB101-FB201-LA221  
 ·Diametro35\_Cross-PR53 ·FB101-FB201 ·Diametro35\_Elegance-PR54 ·  
 FB101-FB201 ·Diametro35\_Inox\_0139SP-0140(S/P)  
 ·Diametro35\_Inox\_Concrete\_0139SP-0140(S/P) ·Reverso ·6040(S/P)  
 ·Pois-PR31 ·FB101-FB201 ·Glitter-PR32 ·FB101-FB201 ·Tie-PR34 ·  
 FB101-FB201 ·Taormina-PR35 ·LA221 ·Tab-PR37 ·FB101-FB201 ·Tip-PR38 ·  
 FB101-FB201 ·Haptic-PR43 ·FM101-FM201-LA221 ·DOT316-PR50 ·  
 FB101-FB201 ·Haptic-PR43 ·FM101-FM201-LA221 ·DOT316-PR50 ·  
 FB111-FB201-FB211-FB221-LA221 ·Comandi\_Wellness-PR28 ·  
 HB203-HB204-HB205 ·Comandi\_Wellness-PR47 ·LA221-LA231  
 für ·Diametro35\_0139SP-0140(S/P) ·Diametro35\_Impronte-PR51 ·  
 FM101-FM201 ·Diametro35\_S-PR52 ·FB101-FB201-LA221  
 ·Diametro35\_Cross-PR53 ·FB101-FB201 ·Diametro35\_Elegance-PR54 ·  
 FB101-FB201 ·Diametro35\_Inox\_0139SP-0140(S/P)  
 ·Diametro35\_Inox\_Concrete\_0139SP-0140(S/P) ·Reverso ·6040(S/P)  
 ·Pois-PR31 ·FB101-FB201 ·Glitter-PR32 ·FB101-FB201 ·Tie-PR34 ·  
 FB101-FB201 ·Taormina-PR35 ·LA221 ·Tab-PR37 ·FB101-FB201 ·Tip-PR38 ·  
 FB101-FB201 ·Haptic-PR43 ·FM101-FM201-LA221 ·DOT316-PR50 ·  
 FB101-FB201 ·Haptic-PR43 ·FM101-FM201-LA221 ·DOT316-PR50 ·  
 FB111-FB201-FB211-FB221-LA221 ·Comandi\_Wellness-PR28 ·  
 HB203-HB204-HB205 ·Comandi\_Wellness-PR47 ·LA221-LA231  
 pour ·Diametro35\_0139SP-0140(S/P) ·Diametro35\_Impronte-PR51 ·  
 FM101-FM201 ·Diametro35\_S-PR52 ·FB101-FB201-LA221  
 ·Diametro35\_Cross-PR53 ·FB101-FB201 ·Diametro35\_Elegance-PR54 ·  
 FB101-FB201 ·Diametro35\_Inox\_0139SP-0140(S/P)  
 ·Diametro35\_Inox\_Concrete\_0139SP-0140(S/P) ·Reverso ·6040(S/P)  
 ·Pois-PR31 ·FB101-FB201 ·Glitter-PR32 ·FB101-FB201 ·Tie-PR34 ·  
 FB101-FB201 ·Taormina-PR35 ·LA221 ·Tab-PR37 ·FB101-FB201 ·Tip-PR38 ·  
 FB101-FB201 ·Haptic-PR43 ·FM101-FM201-LA221 ·DOT316-PR50 ·  
 FB101-FB201 ·Haptic-PR43 ·FM101-FM201-LA221 ·DOT316-PR50 ·  
 FB111-FB201-FB211-FB221-LA221 ·Comandi\_Wellness-PR28 ·  
 HB203-HB204-HB205 ·Comandi\_Wellness-PR47 ·LA221-LA231  
 para ·Diametro35\_0139SP-0140(S/P) ·Diametro35\_Impronte-PR51 ·  
 FM101-FM201 ·Diametro35\_S-PR52 ·FB101-FB201-LA221  
 ·Diametro35\_Cross-PR53 ·FB101-FB201 ·Diametro35\_Elegance-PR54 ·  
 FB101-FB201 ·Diametro35\_Inox\_0139SP-0140(S/P)  
 ·Diametro35\_Inox\_Concrete\_0139SP-0140(S/P) ·Reverso ·6040(S/P)  
 ·Pois-PR31 ·FB101-FB201 ·Glitter-PR32 ·FB101-FB201 ·Tie-PR34 ·  
 FB101-FB201 ·Taormina-PR35 ·LA221 ·Tab-PR37 ·FB101-FB201 ·Tip-PR38 ·  
 FB101-FB201 ·Haptic-PR43 ·FM101-FM201-LA221 ·DOT316-PR50 ·  
 FB101-FB201 ·Haptic-PR43 ·FM101-FM201-LA221 ·DOT316-PR50 ·  
 FB111-FB201-FB211-FB221-LA221 ·Comandi\_Wellness-PR28 ·  
 HB203-HB204-HB205 ·Comandi\_Wellness-PR47 ·LA221-LA231

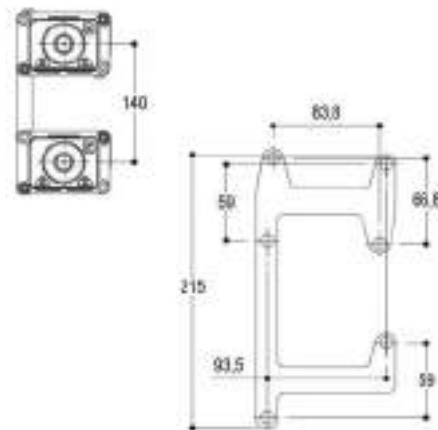

7Z0006



**Staffa orizzontale di fissaggio per miscelatore incasso doppio**  
 Fixing brackets for double shower mixer for horizontal installation  
 Horizontale Montagehalterung für UP-Doppel-Mischer  
 Support de fixation pour double mitigeur à encastrer en horizontal  
 Soporte de montaje para mezclador empotrado horizontal doble

per ·Diametro35\_0140(S/P) ·Diametro35\_Impronte-PR51 ·  
**FM101-FM201 ·Diametro35\_S-PR52 ·FB101-FB201**  
 ·Diametro35\_Cross-PR53 ·FB101-FB201 ·Diametro35\_Elegance-PR54 ·  
**FB101-FB201 ·Diametro35\_Inox\_0140(S/P)**  
 ·Diametro35\_Inox\_Concrete\_0140(S/P) ·Reverso ·6040(S/P)  
 ·Pois-PR31 ·FB101-FB201 ·Glitter-PR32 ·FB101-FB201 ·Tie-PR34 ·  
**FB101-FB201 ·Tab-PR37 ·FB101-FB201 ·Tip-PR38 ·FB101-FB201**  
**·Haptic-PR43 ·FM101-FM201 ·DOT316-PR50 ·**  
**FB111-FB201-FB211-FB221 ·Comandi\_Wellness-PR28 ·**  
**HB203-HB204-HB205**  
 for ·Diametro35\_0140(S/P) ·Diametro35\_Impronte-PR51 ·FM101-FM201  
 ·Diametro35\_S-PR52 ·FB101-FB201 ·Diametro35\_Cross-PR53 ·  
 FB101-FB201 ·Diametro35\_Elegance-PR54 ·FB101-FB201  
 ·Diametro35\_Inox\_0140(S/P) ·Diametro35\_Inox\_Concrete\_0140(S/P)  
 ·Reverso ·6040(S/P) ·Pois-PR31 ·FB101-FB201 ·Glitter-PR32 ·FB101-FB201  
 ·Tie-PR34 ·FB101-FB201 ·Tab-PR37 ·FB101-FB201 ·Tip-PR38 ·  
 FB101-FB201 ·Haptic-PR43 ·FM101-FM201 ·DOT316-PR50 ·  
 FB111-FB201-FB211-FB221 ·Comandi\_Wellness-PR28 ·  
 HB203-HB204-HB205  
 für ·Diametro35\_0140(S/P) ·Diametro35\_Impronte-PR51 ·FM101-FM201  
 ·Diametro35\_S-PR52 ·FB101-FB201 ·Diametro35\_Cross-PR53 ·  
 FB101-FB201 ·Diametro35\_Elegance-PR54 ·FB101-FB201  
 ·Diametro35\_Inox\_0140(S/P) ·Diametro35\_Inox\_Concrete\_0140(S/P)  
 ·Reverso ·6040(S/P) ·Pois-PR31 ·FB101-FB201 ·Glitter-PR32 ·FB101-FB201  
 ·Tie-PR34 ·FB101-FB201 ·Tab-PR37 ·FB101-FB201 ·Tip-PR38 ·  
 FB101-FB201 ·Haptic-PR43 ·FM101-FM201 ·DOT316-PR50 ·  
 FB111-FB201-FB211-FB221 ·Comandi\_Wellness-PR28 ·  
 HB203-HB204-HB205  
 pour ·Diametro35\_0140(S/P) ·Diametro35\_Impronte-PR51 ·FM101-FM201  
 ·Diametro35\_S-PR52 ·FB101-FB201 ·Diametro35\_Cross-PR53 ·  
 FB101-FB201 ·Diametro35\_Elegance-PR54 ·FB101-FB201  
 ·Diametro35\_Inox\_0140(S/P) ·Diametro35\_Inox\_Concrete\_0140(S/P)  
 ·Reverso ·6040(S/P) ·Pois-PR31 ·FB101-FB201 ·Glitter-PR32 ·FB101-FB201  
 ·Tie-PR34 ·FB101-FB201 ·Tab-PR37 ·FB101-FB201 ·Tip-PR38 ·  
 FB101-FB201 ·Haptic-PR43 ·FM101-FM201 ·DOT316-PR50 ·  
 FB111-FB201-FB211-FB221 ·Comandi\_Wellness-PR28 ·  
 HB203-HB204-HB205  
 para ·Diametro35\_0140(S/P) ·Diametro35\_Impronte-PR51 ·FM101-FM201  
 ·Diametro35\_S-PR52 ·FB101-FB201 ·Diametro35\_Cross-PR53 ·  
 FB101-FB201 ·Diametro35\_Elegance-PR54 ·FB101-FB201  
 ·Diametro35\_Inox\_0140(S/P) ·Diametro35\_Inox\_Concrete\_0140(S/P)  
 ·Reverso ·6040(S/P) ·Pois-PR31 ·FB101-FB201 ·Glitter-PR32 ·FB101-FB201  
 ·Tie-PR34 ·FB101-FB201 ·Tab-PR37 ·FB101-FB201 ·Tip-PR38 ·  
 FB101-FB201 ·Haptic-PR43 ·FM101-FM201 ·DOT316-PR50 ·  
 FB111-FB201-FB211-FB221 ·Comandi\_Wellness-PR28 ·  
 HB203-HB204-HB205

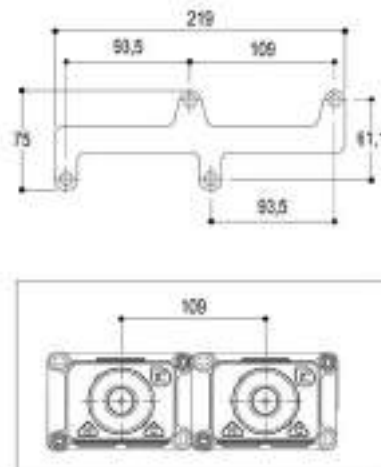

7Z0007

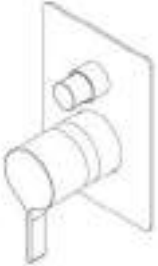
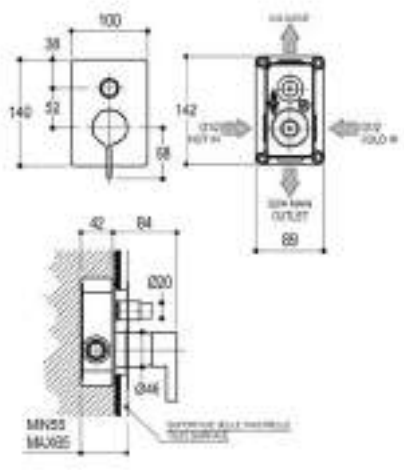

	<p><b>Miscelatore monocomando ad incasso per vasca/doccia</b>  <i>Built-in single lever bath/shower mixer</i>  <i>Einhandmischer für Badewanne/Dusche</i>  <i>Mitigeur monocommande à encastrer pour baignoire/douche</i>  <i>Mezclador monomando empotrado para bañera/ducha</i></p> <p><b>_ due uscite _ deviatore automatico vasca/doccia _ completo di parti interne</b>  <i>_ two ways _ automatic diverter bath/shower _ complete of inner parts</i>  <i>_ zwei Abgänge _ Automatische Umstellung von Wanne auf Dusche _ komplett mit UP-Teilen</i>  <i>_ deux sorties _ inverseur automatique bain/douche _ complet avec parties internes</i>  <i>_ dos salidas _ desviador automático bañera/ducha _ completo de partes internas</i></p>	
---	--	---

	<p><b>Parti esterne</b>  <i>Outer parts / Fertigset / Parties externes / Partes externas</i></p>	<p><b>PR34GC101</b> <b>CRL</b>  <b>IX, CRB, BLX</b></p>
---	--	---

	<p><b>Parti da incasso</b>  <i>Built-in parts / UP-teile / Parties internes / Partes internas</i></p>	<p><b>E0BA0153</b> € 129,0</p>
--	---	--------------------------------

<p><b>Miscelatore completo</b>  <i>Complete mixer / Vollständige Mischer / Mitigeur complete / Mezclador completo</i></p>		<p><b>PR34GB101</b> <b>CRL</b>  <b>IX, CRB, BLX</b></p>
---	--	---

Accessori / Accessories / Zubehör / Accessoires / Accesorios

Prolunghe / Extensions / Verlängerungen / Rallonges / Prolongadoras & Ricambi / Spare parts / Ersatzteile / Pièces de rechange / Recambios

							
RCMB069H1 pag. 1202	RCMB069H2 pag. 1203	RCMB015 pag. 1213	RCMB035 pag. 1214	RCMB509 pag. 1221	RCMB526 pag. 1222	RCMB585 pag. 1224	RCMB742 pag. 1231

POIS  
TIE  
TIP  
TAB  
REVERSO  
RITRÒ  
ELEMENTA ACCESSORI  
ELEMENTA IMPRONTE ACCESSORI  
ACCESSORI  
COMPLEMENTI WC  
PILETTI  
SIFONI DI SCARICO

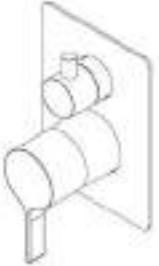

**Miscelatore monocomando ad incasso per vasca/doccia**  
*Built-in single lever bath/shower mixer*  
*Einhandmischer für Badewanne/Dusche*  
*Mitigeur monocommande à encastrer pour baignoire/douche*  
*Mezclador monomando empotrado para bañera/ducha*

---

**due uscite con deviatore rotativo \_ completo di parti interne**  
*two ways with rotative diverter \_ complete of inner parts*  
*zwei Abgänge mit Drehumsteller \_ komplett mit UP-Teilen*  
*deux sorties avec inverseur rotatif \_ complet avec parties internes*  
*dos salidas con mando desviador giratorio \_ completo de partes internas*

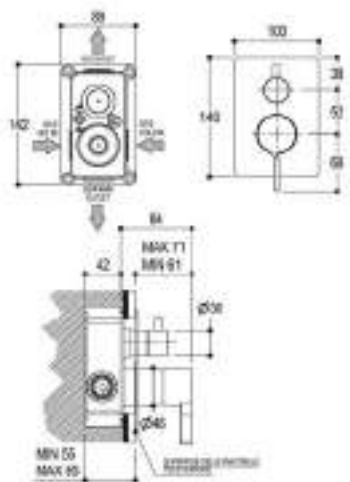

IN  
1/2"

OUT  
1/2"



**Parti esterne**  
*Outer parts / Fertigset / Parties externes / Partes externas*

**PR34GC111**

**CRL**  
**IX, CRB, BLX**

+



**Parti da incasso**  
*Built-in parts / UP-teile / Parties internes / Partes internas*

**PM0020M**

=

**Miscelatore completo**  
*Complete mixer / Vollständige Mischer / Mitigeur complete / Mezclador completo*

**PR34GB111**

**CRL**  
**IX, CRB, BLX**

Accessori / Accessories / Zubehör / Accessoires / Accesorios

Ricambi / Spare parts / Ersatzteile / Pièces de rechange / Recambios

- |   |   |   |   |   |   |
|---|---|---|---|---|---|
|  |  |  |  |  |  |
| RCMB015<br>pag. 1213  | RCMB585<br>pag. 1224  | RCMB742<br>pag. 1231  | RCMBA108<br>pag. 1246   | RCMBA153<br>pag. 1249   | RCMBA173<br>pag. 1251   |

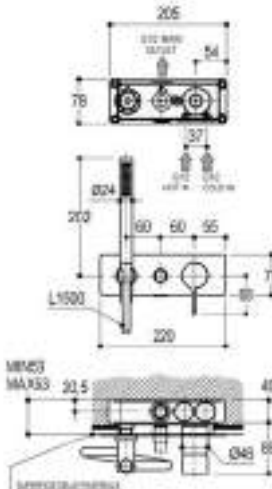
 <div data-bbox="199 549 309 604"> <p>IN 1/2" OUT 1/2"</p> </div>	<p><b>Miscelatore monocomando ad incasso per vasca/doccia</b>  <i>Built-in single lever bath/shower mixer</i>  <i>Einhandmischer für Badewanne/Dusche</i>  <i>Mitigeur monocommande à encastrer pour baignoire/douche</i>  <i>Mezclador monomando empotrado para bañera/ducha</i></p> <hr/> <p><b>due uscite con deviatore automatico, una uscita a vasca/doccia l'altra a doccetta _ doccetta Ø24mm in ottone con flessibile da 1500mm _ completo di parti interne</b>  <i>two outlets with automatic diverter: one outlet bath/shower the other hand shower with 1.500mm flexible hose _ brass Ø24mm hand shower _ complete of inner parts</i>  <i>zwei Abgänge mit automatischer Umstellung ein Abgang Wanne/Dusche, der andere Handbrause _ Handbrause Ø24mm aus messing mit Schlauch 1500mm _ komplett mit UP-Teilen</i>  <i>deux sorties avec inverseur automatique, une sortie baignoire/douche, l'autre douchette _ douchette Ø24mm en laiton avec flexible de 1500mm _ complet avec parties internes</i>  <i>dos salidas con desviador automatico, una salida bañera/ducha, la otra douchita _ ducha teléfono Ø24mm en latón con flexible de 1500mm _ completo de partes internas</i></p>	
--	--	---

	<p><b>Parti esterne</b>  <i>Outer parts / Fertigset / Parties externes / Partes externas</i></p>	<p><b>PR34GG101</b> <b>CRL</b>  <b>IX, CRB, BLX</b></p>
---	--	---

	<p><b>Parti da incasso</b>  <i>Built-in parts / UP-teile / Parties internes / Partes internas</i></p>	<p><b>PM0020D</b></p>
--	---	-----------------------

<p><b>Miscelatore completo</b>  <i>Complete mixer / Vollständige Mischer / Mitigeur complete / Mezclador completo</i></p>	<p><b>PR34GF101</b> <b>CRL</b>  <b>IX, CRB, BLX</b></p>
---	---

Accessori / Accessories / Zubehör / Accessoires / Accesorios

Prolunghe / Extensions / Verlängerungen / Rallonges / Prolongadoras & Ricambi / Spare parts / Ersatzteile / Pièces de rechange / Recambios

 <p><b>+20mm</b>  RCMB521H1  pag. 1203</p>	 <p><b>+40mm</b>  RCMB521H2  pag. 1203</p>	 <p>RCMB015  pag. 1213</p>	 <p>RCMB035  pag. 1214</p>	 <p>RCMB519  pag. 1222</p>	 <p>RCMB526  pag. 1222</p>	 <p>RCMB585  pag. 1224</p>	 <p>RCMB742  pag. 1231</p>
---	---	---	---	---	---	---	---

POIS  
TIE  
TIP  
TAB  
REVERSO  
RITRÒ  
ELEMENTA IMPRONTA ACCESSORI  
ELEMENTA IMPRONTA ACCESSORI  
ACCESSORI  
COMPLEMENTI WC  
PILETTI  
SIFONI DI SCARICO



**Miscelatore termostatico ad incasso**  
 Built-in thermostatic mixer  
 Thermostat UP-Mischer  
 Mitigeur thermostatique à encastrer  
 Mezclador termostático empotrado

— **regolatore di portata \_ una uscita \_ completo di parti interne**  
 — flow regulator \_ one way \_ with inner parts  
 — Absperrung \_ Ein Abgang \_ mit UP-Teilen  
 — régulateur de débit \_ une sortie \_ avec parties internes  
 — regulador de caudal \_ una salida \_ completo de partes internas

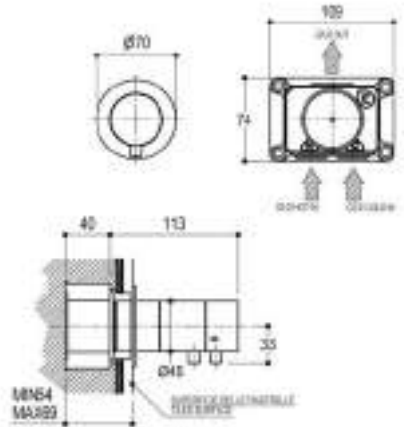

**IN**  
1/2"

**OUT**  
1/2"



**Parti esterne**  
 Outer parts / Fertigset / Parties externes / Partes externas

**PR28HC203** **CRL**  
 IX, CRB, BLX

**Parti da incasso**  
 Built-in parts / UP-teile / Parties internes / Partes internas

**PM0030D** **CRL**  
 IX, CRB, BLX



**Miscelatore completo**  
 Complete mixer / Vollständige Mischer / Mitigeur complete / Mezclador completo

**PR28HB203** **CRL**  
 IX, CRB, BLX

Accessori / Accessories / Zubehör / Accessoires / Accesorios

Prolunghe / Extensions / Verlängerungen / Rallonges / Prolongadoras & Ricambi / Spare parts / Ersatzteile / Pièces de rechange / Recambios



**+20mm**  
RCMB556H1  
pag. 1203

**+40mm**  
RCMB556H2  
pag. 1203

RCMB561  
pag. 1223

RCMB562  
pag. 1223

RCMB563  
pag. 1223

RCMB721  
pag. 1231

RCMBA152  
pag. 1249

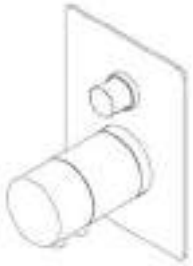
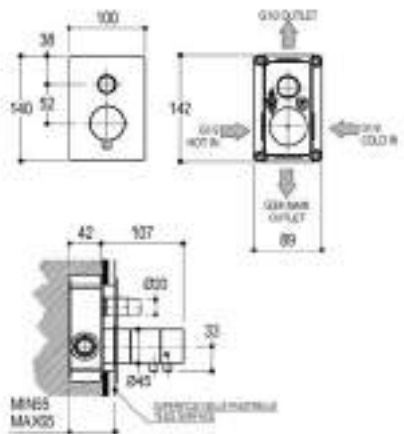
 <div style="display: flex; justify-content: space-around; margin-top: 10px;"> <div style="border: 1px solid black; padding: 2px; font-size: 8px;">IN 1/2"</div> <div style="border: 1px solid black; padding: 2px; font-size: 8px;">OUT 1/2"</div> </div>	<p><b>Miscelatore termostatico ad incasso</b>  <i>Built-in thermostatic mixer</i>  <i>UP-Thermostatmischer</i>  <i>Mitigeur thermostatique à encastrer</i>  <i>Mezclador termostático empotrado</i></p> <hr/> <p><b>_ regolatore di portata _ due uscite _ completo di parti interne</b>  <i>_ flow regulator _ two exits _ with inner parts</i>  <i>_ Absperrung _ zwei Abgänge _ mit UP-Teilen</i>  <i>_ régulateur de débit _ deux sorties _ avec parties internes</i>  <i>_ regulador de caudal _ dos salidas _ completo de partes internas</i></p>	
---	---	---

	<p><b>Parti esterne</b>  <i>Outer parts / Fertigset / Parties externes / Partes externas</i></p>	<p><b>PR28HE101</b>    <b>CRL</b>  <b>IX, CRB, BLX</b></p>
---	--	--

	<p><b>Parti da incasso</b>  <i>Built-in parts / UP-teile / Parties internes / Partes internas</i></p>	<p><b>PM0030E</b>    <b>CRL</b>  <b>IX, CRB, BLX</b></p>
--	---	--

<p><b>Miscelatore completo</b>  <i>Complete mixer / Vollständige Mischer / Mitigeur complete / Mezclador completo</i></p>	<p><b>PR28HD101</b>    <b>CRL</b>  <b>IX, CRB, BLX</b></p>
---	--

Accessori / Accessories / Zubehör / Accessoires / Accesorios

Prolunghe / Extensions / Verlängerungen / Rallonges / Prolongadoras & Ricambi / Spare parts / Ersatzteile / Pièces de rechange / Recambios

<b>+20mm</b> RCMB557H1 pag. 1203	<b>+40mm</b> RCMB557H2 pag. 1203	RCMB035 pag. 1214	RCMB526 pag. 1222	RCMB561 pag. 1223	RCMB562 pag. 1223	RCMB563 pag. 1223	RCMB721 pag. 1231	RCMBA116 pag. 1247

POIS  
TIE  
TIP  
TAB  
REVERSO  
RITRÒ  
ELEMENTA ACCESSORI  
ELEMENTA IMPRONTE ACCESSORI  
ACCESSORI  
COMPLEMENTI WC  
PILETTI  
SIFONI DI SCARICO

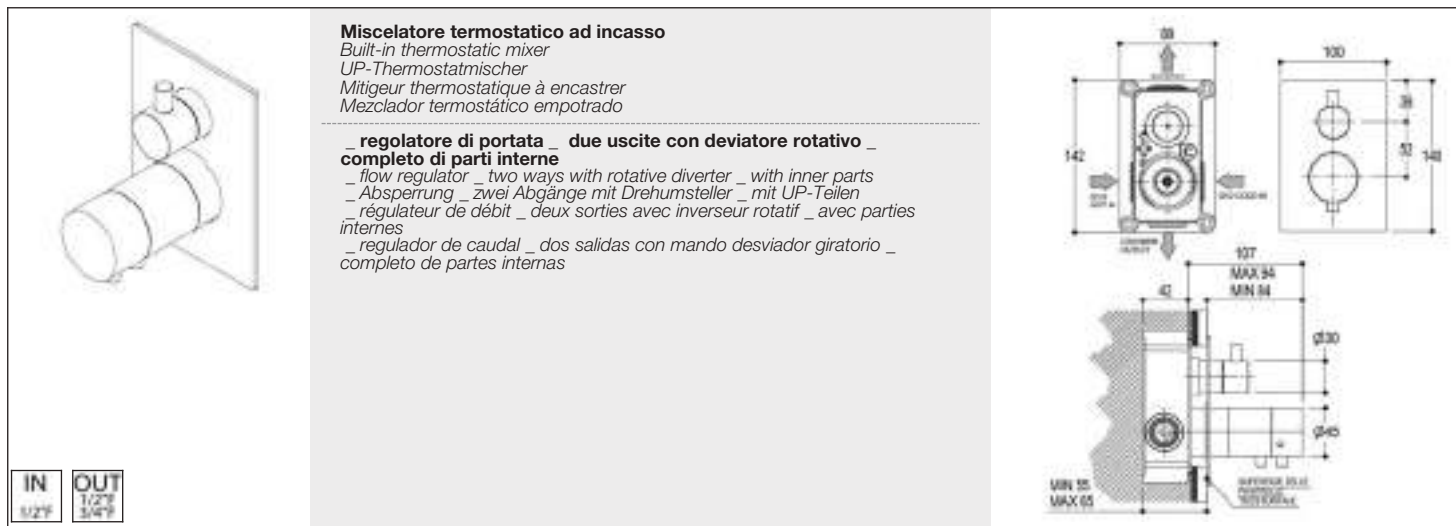

**Miscelatore termostatico ad incasso**  
 Built-in thermostatic mixer  
 UP-Thermostatmischer  
 Mitigeur thermostatique à encastrer  
 Mezclador termostático empotrado

**\_ regolatore di portata \_ due uscite con deviatore rotativo \_ completo di parti interne**  
 \_ flow regulator \_ two ways with rotative diverter \_ with inner parts  
 \_ Absperrung \_ zwei Abgänge mit Drehumsteller \_ mit UP-Teilen  
 \_ régulateur de débit \_ deux sorties avec inverseur rotatif \_ avec parties internes  
 \_ regulador de caudal \_ dos salidas con mando desviador giratorio \_ completo de partes internas

**IN** 1/2" **OUT** 1/2" 3/4"



**Parti esterne**  
 Outer parts / Fertigset / Parties externes / Partes externas

**PR28HE11** **CRL**  
**IX, CRB, BLX**



**Parti da incasso**  
 Built-in parts / UP-teile / Parties internes / Partes internas

**PM0030N** **CRL**  
**IX, CRB, BLX**

**Miscelatore completo**  
 Complete mixer / Vollständige Mischer / Mitigeur complete / Mezclador completo

**PR28HD11** **CRL**  
**IX, CRB, BLX**

Accessori / Accessories / Zubehör / Accessoires / Accesorios

Ricambi / Spare parts / Ersatzteile / Pièces de rechange / Recambios

-  RCMB561  
pag. 1223
-  RCMB562  
pag. 1223
-  RCMB563  
pag. 1223
-  RCMB721  
pag. 1231
-  RCMBA108  
pag. 1246
-  RCMBA153  
pag. 1249
-  RCMBA157  
pag. 1250

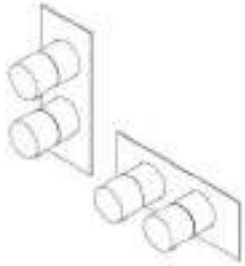
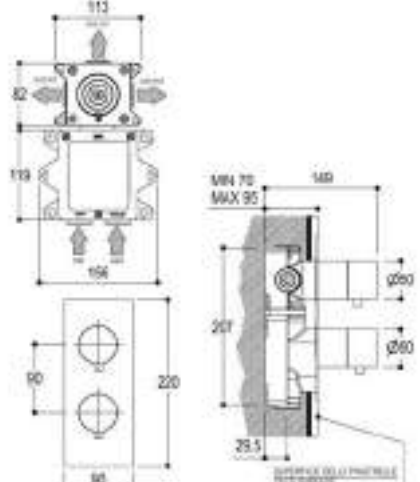
 <div style="display: flex; justify-content: space-around; margin-top: 10px;"> <div style="border: 1px solid black; padding: 2px; font-size: 8px;">IN 3/4"</div> <div style="border: 1px solid black; padding: 2px; font-size: 8px;">OUT 1/2"</div> </div>	<p><b>Miscelatore termostatico ad incasso</b>  <i>Built-in thermostatic mixer</i>  <i>UP-Thermostatmischer</i>  <i>Mitigeur thermostatique à encastrer</i>  <i>Mezclador termostático empotrado</i></p> <p><b>_ regolatore di portata _ due/tre uscite: vasca-doccetta-soffione con posizioni di stop intermedie _ piastra esterna _ filtri e valvole di non ritorno _ completo di parti interne _ installabile in posizione verticale oppure orizzontale</b>  <i>_ flow regulator _ two/three ways out: bath-hand shower-head shower with intermediate stop positions _ external plate _ filters and non return valves _ with inner parts _ installation in both vertical and horizontal position</i>  <i>_ Durchflussregler _ Zwei- und Dreiwege-Umstellung: Badewanne-Dusche-Kopfbrause mit Zwischenhaltpositionen</i>  <i>_ Montageplatte _ Filter und Rückschlagventil _ mit UP-Teilen _ horizontal oder vertikal installierbar</i>  <i>_ régulateur de débit _ deux/trois sorties: baignoire-douchette-tête de douche avec positions de stop intermédiaires _ plaque extérieure _ filtres et soupapes de non retour _ avec parties internes _ possible installation en vertical ou horizontal</i>  <i>_ regulador de caudal _ dos/tres salidas: bañera-ducha teléfono-rociador con posiciones de stop intermedias _ placa externa _ filtros y válvulas sin regreso _ completo de partes internas _ instalación en posición horizontal o vertical</i></p>	
---	--	---

	<p><b>Parti esterne</b>  <i>Outer parts / Fertigset / Parties externes / Partes externas</i></p>	<p><b>PR47HG101</b> <b>CRL</b>  <b>IX, CRB, BLX</b></p>
---	--	---

	<p><b>Parti da incasso</b>  <i>Built-in parts / UP-teile / Parties internes / Partes internas</i></p>	<p><b>PM0030K</b></p>
--	---	-----------------------

<p><b>Miscelatore completo</b>  <i>Complete mixer / Vollständige Mischer / Mitigeur complete / Mezclador completo</i></p>	<p><b>PR47HF101</b> <b>CRL</b>  <b>IX, CRB, BLX</b></p>
---	---

Accessori / Accessories / Zubehör / Accessoires / Accesorios

Ricambi / Spare parts / Ersatzteile / Pièces de rechange / Recambios

						
RCMB828 pag. 1235	RCMB829 pag. 1235	RCMB833 pag. 1235	RCMB840 pag. 1235	RCMB909 pag. 1240	RCMB954 pag. 1241	RCMBA020 pag. 1244

POIS  
 TIE  
 TIP  
 TAB  
 REVERSO  
 RITRÒ  
 ELEMENTA ACCESSORI  
 ELEMENTA IMPRONTE ACCESSORI  
 ACCESSORI  
 COMPLEMENTI WC  
 PILETTE  
 SIFONI DI SCARICO

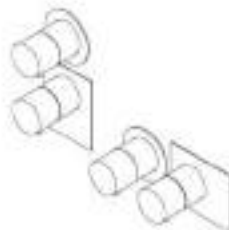

**Miscelatore termostatico ad incasso**  
 Built-in thermostatic mixer  
 UP-Thermostatmischer  
 Mitigeur thermostatique à encastrer  
 Mezclador termostático empotrado

**\_ regolatore di portata \_ due/tre uscite: vasca-doccetta-soffione con posizioni di stop intermedie \_ filtri e valvole di non ritorno \_ completo di parti interne \_ installabile in posizione verticale oppure orizzontale**  
 \_ flow regulator \_ two/three ways out: bath-hand shower-head shower with intermediate stop positions \_ filters and non return valves \_ with inner parts \_ installation in both vertical and horizontal position  
 \_ Durchflussregler \_ Zwei- und Dreiwege-Umstellung:  
 Badewanne-Dusche-Kopfbrause mit Zwischenhaltpositionen \_ Filter und Rückschlagventil \_ mit UP-Teilen \_ horizontal oder vertikal installierbar  
 \_ régulateur de débit \_ deux/trois sorties: baignoire-douchette-tête de douche avec positions de stop intermédiaires \_ filtres et soupapes de non retour \_ avec parties internes \_ possible installation en vertical ou horizontal  
 \_ regulador de caudal \_ dos/tres salidas: bañera-ducha teléfono-rociador con posiciones de stop intermedias \_ filtros y válvulas sin regreso \_ completo de partes internas \_ instalación en posición horizontal o vertical

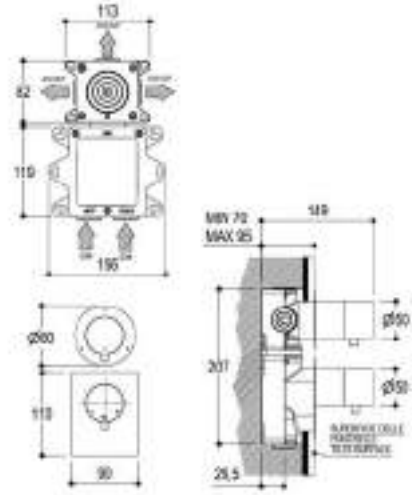

IN  
3/4"

OUT  
1/2"



**Parti esterne**  
 Outer parts / Fertigset / Parties externes / Partes externas

**PR47HG202**

**CRL**  
**IX, CRB, BLX**



**Parti da incasso**  
 Built-in parts / UP-teile / Parties internes / Partes internas

**PM0030K**



**Miscelatore completo**  
 Complete mixer / Vollständige Mischer / Mitigeur complete / Mezclador completo

**PR47HF202**

**CRL**  
**IX, CRB, BLX**

Accessori / Accessories / Zubehör / Accessoires / Accesorios

Ricambi / Spare parts / Ersatzteile / Pièces de rechange / Recambios



RCMB828  
pag. 1235



RCMB829  
pag. 1235



RCMB833  
pag. 1235



RCMB840  
pag. 1235



RCMB909  
pag. 1240



RCMB954  
pag. 1241



RCMB996  
pag. 1243



RCMA013  
pag. 1244

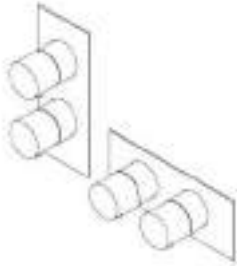
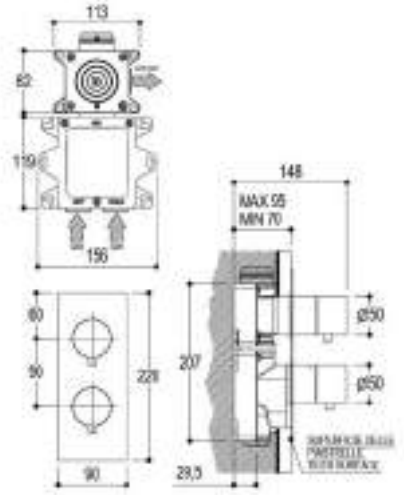

 <div style="display: flex; justify-content: space-around; margin-top: 10px;"> <div style="border: 1px solid black; padding: 2px; font-size: 8px;">IN 1/4"</div> <div style="border: 1px solid black; padding: 2px; font-size: 8px;">OUT 1/4"</div> </div>	<p><b>Miscelatore termostatico ad incasso</b>  <i>Built-in thermostatic mixer</i>  <i>Thermostat UP-Mischer</i>  <i>Mitigeur thermostatique à encastrer</i>  <i>Mezclador termostático empotrado</i></p> <p><b>_ regolatore di portata _ piastra esterna _ filtri e valvole di non ritorno _ una uscita _ completo di parti interne _ installabile in posizione verticale oppure orizzontale</b>  <i>_ flow regulator _ external plate _ filters and non return valves _ one way _ with inner parts _ installation in both vertical and horizontal position</i>  <i>_ Absperrung _ Montageplatte _ Filter und Rückschlagventil _ Ein Abgang _ mit UP-Teilen _ horizontal oder vertikal installierbar</i>  <i>_ régulateur de débit _ plaque externe _ filtres et soupapes de non retour _ une sortie _ avec parties internes _ possible installation en vertical ou horizontal</i>  <i>_ regulador de caudal _ plancha externa _ filtros y válvulas sin regreso _ una salida _ completo de partes internas _ instalación en posición horizontal o vertical</i></p>	
---	--	---







	<p><b>Parti esterne</b>  <i>Outer parts / Fertigset / Parties externes / Partes externas</i></p>	<p><b>PR47HC102</b> <b>CRL</b>  <b>IX, CRB, BLX</b></p>
---	--	---

	<p><b>Parti da incasso</b>  <i>Built-in parts / UP-teile / Parties internes / Partes internas</i></p>	<p><b>PM0030H</b></p>
--	---	-----------------------

<p><b>Miscelatore completo</b>  <i>Complete mixer / Vollständige Mischer / Mitigeur complete / Mezclador completo</i></p>	<p><b>PR47HB102</b> <b>CRL</b>  <b>IX, CRB, BLX</b></p>
---	---

Accessori / Accessories / Zubehör / Accessoires / Accesorios

Ricambi / Spare parts / Ersatzteile / Pièces de rechange / Recambios

					
RCMB353 pag. 1219	RCMB828 pag. 1235	RCMB829 pag. 1235	RCMB833 pag. 1235	RCMB840 pag. 1235	RCMBA004 pag. 1243

POIS  
 TIE  
 TIP  
 TAB  
 REVERSO  
 RITRÒ  
 ELEMENTA ACCESSORI  
 ELEMENTA IMPRONTE ACCESSORI  
 ACCESSORI  
 COMPLEMENTI WC  
 PILETTE  
 SIFONI DI SCARICO

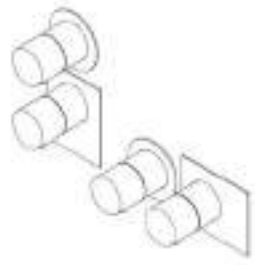

**Miscelatore termostatico ad incasso**  
 Built-in thermostatic mixer  
 Thermostat UP-Mischer  
 Mitigeur thermostatique à encastrer  
 Mezclador termostático empotrado

**\_ regolatore di portata \_ filtri e valvole di non ritorno \_ una uscita \_ completo di parti interne \_ installabile in posizione verticale oppure orizzontale**  
 \_ flow regulator \_ filters and non return valves \_ one way \_ with inner parts \_ installation in both vertical and horizontal position  
 \_ Absperrung \_ Filter und Rückschlagventil \_ Ein Abgang \_ mit UP-Teilen \_ horizontal oder vertikal installierbar  
 \_ régulateur de débit \_ filtres et soupapes de non retour \_ une sortie \_ avec parties internes \_ possible installation en vertical ou horizontal  
 \_ regulador de caudal \_ filtros y válvulas sin regreso \_ una salida \_ completo de partes internas \_ instalación en posición horizontal o vertical

IN  
1/4"

OUT  
1/4"



**Parti esterne**  
 Outer parts / Fertigset / Parties externes / Partes externas

**PR47HC201**

**CRL**  
**IX, CRB, BLX**



**Parti da incasso**  
 Built-in parts / UP-teile / Parties internes / Partes internas

**PM0030H**



**Miscelatore completo**  
 Complete mixer / Vollständige Mischer / Mitigeur complete / Mezclador completo

**PR47HB201**

**CRL**  
**IX, CRB, BLX**

Accessori / Accessories / Zubehör / Accessoires / Accesorios

Ricambi / Spare parts / Ersatzteile / Pièces de rechange / Recambios



RCMB353  
pag. 1219



RCMB828  
pag. 1235



RCMB829  
pag. 1235



RCMB833  
pag. 1235



RCMB840  
pag. 1235





RCMB996  
pag. 1243

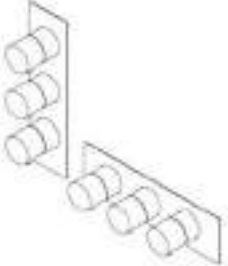
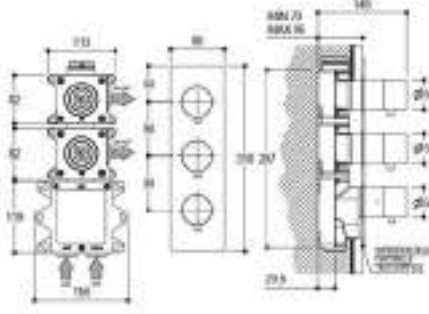

RCMBA012  
pag. 1244

	<p><b>Miscelatore termostatico ad incasso</b>  <i>Built-in thermostatic mixer</i>  <i>UP-Thermostatmischer</i>  <i>Mitigeur thermostatique à encastrer</i>  <i>Mezclador termostático empotrado</i></p> <p><b>_ regolatore di portata _ piastra esterna _ filtri e valvole di non ritorno _ due uscite indipendenti _ completo di parti interne _ installabile in posizione verticale oppure orizzontale</b>  <i>_ flow regulator _ external plate _ filters and non return valves _ two separate exits _ with inner parts _ installation in both vertical and horizontal position</i>  <i>Absperrung _ Montageplatte _ Filter und Rückschlagventil _ zwei separate Abgänge _ mit UP-Teilen _ horizontal oder vertikal installierbar</i>  <i>_ régulateur de débit _ plaque externe _ filtres et soupapes de non retour _ deux sorties indépendantes _ avec parties internes _ possible installation en vertical ou horizontal</i>  <i>_ regulador de caudal _ plancha externa _ filtros y válvulas sin regreso _ dos salidas independientes _ completo de partes internas _ instalación en posición horizontal o vertical</i></p>	
<p>IN 1/4" F          OUT 2x 3/4" F</p>		

	<p><b>Parti esterne</b>  <i>Outer parts / Fertigset / Parties externes / Partes externas</i></p>	<p><b>PR47HE101</b> <b>CRL</b>  <b>IX, CRB, BLX</b></p>
	<p><b>Parti da incasso</b>  <i>Built-in parts / UP-teile / Parties internes / Partes internas</i></p>	<p><b>PM0030J</b></p>
<p><b>Miscelatore completo</b>  <i>Complete mixer / Vollständige Mischer / Mitigeur complete / Mezclador completo</i></p>		<p><b>PR47HD101</b> <b>CRL</b>  <b>IX, CRB, BLX</b></p>

Accessori / Accessories / Zubehör / Accessoires / Accesorios

Ricambi / Spare parts / Ersatzteile / Pièces de rechange / Recambios

					
RCMB353 pag. 1219	RCMB828 pag. 1235	RCMB829 pag. 1235	RCMB833 pag. 1235	RCMB840 pag. 1235	RCMBA005 pag. 1243

POIS  
TIE  
TIP  
TAB  
REVERSO  
RITRÒ  
ELEMENTA ACCESSORI  
ELEMENTA IMPRONTE ACCESSORI  
ACCESSORI  
COMPLEMENTI WC  
PILETTE  
SIFONI DI SCARICO

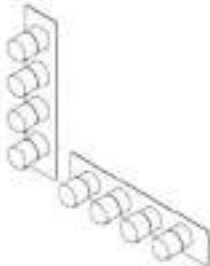
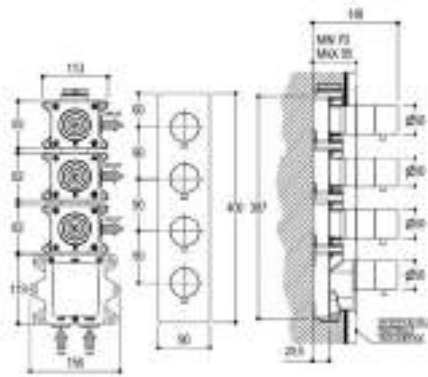

 <div style="display: flex; justify-content: space-around; margin-top: 10px;"> <div style="border: 1px solid black; padding: 2px; font-size: 8px;">IN 1/4"</div> <div style="border: 1px solid black; padding: 2px; font-size: 8px;">OUT 3/4"</div> </div>	<p><b>Miscelatore termostatico ad incasso</b>  <i>Built-in thermostatic mixer</i>  <i>UP-Thermostatmischer</i>  <i>Mitigeur thermostatique à encastrer</i>  <i>Mezclador termostático empotrado</i></p> <p><b>_ regolatore di portata _ piastra esterna _ filtri e valvole di non ritorno _ tre uscite indipendenti _ completo di parti interne _ installabile in posizione verticale oppure orizzontale</b>  <i>_ flow regulator _ external plate _ filters and non return valves _ three separate exits _ with inner parts _ installation in both vertical and horizontal position</i>  <i>_ Absperrung _ Montageplatte _ Filter und Rückschlagventil _ drei separate Abgänge _ mit UP-Teilen _ horizontal oder vertikal installierbar</i>  <i>_ régulateur de débit _ plaque externe _ filtres et soupapes de non retour _ trois sorties indépendantes _ avec parties internes _ possible installation en vertical ou horizontal</i>  <i>_ regulador de caudal _ plancha externa _ filtros y válvulas sin regreso _ tres salidas independientes _ completo de partes internas _ instalación en posición horizontal o vertical</i></p>	
---	--	---







	<p><b>Parti esterne</b>  <i>Outer parts / Fertigset / Parties externes / Partes externas</i></p>	<p><b>PR47HG102</b> <b>CRL</b>  <b>IX, CRB, BLX</b></p>
---	--	---

	<p><b>Parti da incasso</b>  <i>Built-in parts / UP-teile / Parties internes / Partes internas</i></p>	<p><b>PM0030L</b></p>
--	---	-----------------------

<p><b>Miscelatore completo</b>  <i>Complete mixer / Vollständige Mischer / Mitigeur complete / Mezclador completo</i></p>	<p><b>PR47HF102</b> <b>CRL</b>  <b>IX, CRB, BLX</b></p>
---	---

Accessori / Accessories / Zubehör / Accessoires / Accesorios

Ricambi / Spare parts / Ersatzteile / Pièces de rechange / Recambios

					
RCMB353 pag. 1219	RCMB828 pag. 1235	RCMB829 pag. 1235	RCMB833 pag. 1235	RCMB840 pag. 1235	RCMBA006 pag. 1243

POIS

TIE

TIP

TAB

REVERSO

RITRÒ

ELEMENTA ACCESSORI

ELEMENTA IMPRONTE ACCESSORI

ACCESSORI

COMPLEMENTI WC

PILETTE

SIFONI DI SCARICO

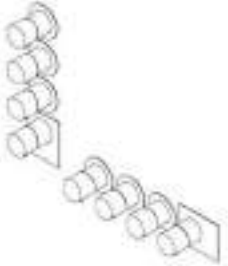

**Miscelatore termostatico ad incasso**  
 Built-in thermostatic mixer  
 UP-Thermostatmischer  
 Mitigeur thermostatique à encastrer  
 Mezclador termostático empotrado

**\_ regolatore di portata \_ filtri e valvole di non ritorno \_ tre uscite indipendenti \_ completo di parti interne \_ installabile in posizione verticale oppure orizzontale**  
 \_ flow regulator \_ filters and non return valves \_ three separate exits \_ with inner parts \_ installation in both vertical and horizontal position  
 \_ Absperrung \_ Filter und Rückschlagventil \_ drei separate Abgänge \_ mit UP-Teilen \_ horizontal oder vertikal installierbar  
 \_ régulateur de débit \_ filtres et soupapes de non retour \_ trois sorties indépendantes \_ avec parties internes \_ possible installation en vertical ou horizontal  
 \_ regulador de caudal \_ filtros y válvulas sin regreso \_ tres salidas independientes \_ completo de partes internas \_ instalación en posición horizontal o vertical

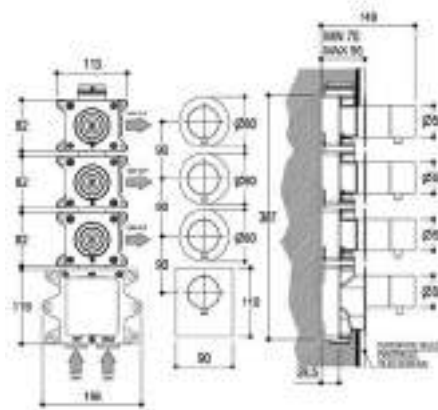

IN  
1/4"

OUT  
1/4"



**Parti esterne**  
 Outer parts / Fertigset / Parties externes / Partes externas

**PR47HG201**

**CRL**  
**IX, CRB, BLX**



**Parti da incasso**  
 Built-in parts / UP-teile / Parties internes / Partes internas

**PM0030L**



**Miscelatore completo**  
 Complete mixer / Vollständige Mischer / Mitigeur complete / Mezclador completo

**PR47HF201**

**CRL**  
**IX, CRB, BLX**

Accessori / Accessories / Zubehör / Accessoires / Accesorios

Ricambi / Spare parts / Ersatzteile / Pièces de rechange / Recambios



RCMB353  
pag. 1219



RCMB828  
pag. 1235



RCMB829  
pag. 1235



RCMB833  
pag. 1235



RCMB840  
pag. 1235



RCMB996  
pag. 1243



RCMBA012  
pag. 1244

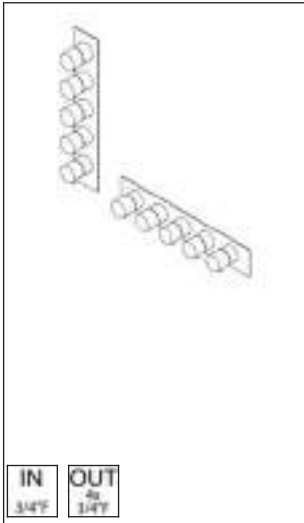

**Miscelatore termostatico ad incasso**

Built-in thermostatic mixer  
UP-Thermostatmischer  
Mitigeur thermostatique à encastrer  
Mezclador termostático empotrado

**\_ regolatore di portata \_ piastra esterna \_ filtri e valvole di non ritorno  
quattro uscite indipendenti \_ completo di parti interne \_ installabile  
in posizione verticale oppure orizzontale**

\_ flow regulator \_ external plate \_ filters and non return valves \_ four  
separate exits \_ with inner parts \_ installation in both vertical and horizontal  
position  
\_ Absperrung \_ Montageplatte \_ Filter und Rückschlagventil \_ vier separate  
Abgänge \_ mit UP-Teilen \_ horizontal oder vertikal installierbar  
\_ régulateur de débit \_ plaque externe \_ filtres et soupapes de non retour \_  
quatre sorties indépendantes \_ avec parties internes \_ possible installation en  
vertical ou horizontal  
\_ regulador de caudal \_ plancha externa \_ filtros y válvulas sin regreso \_  
cuatro salidas independientes \_ completo de partes internas \_ instalación en  
posición horizontal o vertical

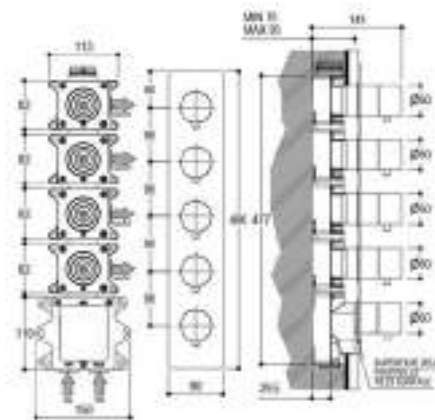

**Parti esterne**

Outer parts / Fertigset / Parties externes / Partes  
externas

**PR47HJ101**

**CRL**  
**IX, CRB, BLX**



**Parti da incasso**

Built-in parts / UP-teile / Parties internes / Partes  
internas

**PM0030M**

**CRL**  
**IX, CRB, BLX**

**Miscelatore completo**  
Complete mixer / Vollständige Mischer / Mitigeur  
complete / Mezclador completo

**PR47HH101**

Accessori / Accessories / Zubehör / Accessoires / Accesorios

Ricambi / Spare parts / Ersatzteile / Pièces de rechange / Recambios



RCMB353  
pag. 1219



RCMB828  
pag. 1235



RCMB829  
pag. 1235



RCMB833  
pag. 1235



RCMB840  
pag. 1235



RCMBA007  
pag. 1243

POIS

TIE

TIP

TAB

REVERSO

RITRÒ

ELEMENTA  
ACCESSORI

ELEMENTA  
IMPRONTE  
ACCESSORI

ACCESSORI

COMPLEMENTI  
WC

PILETTE

SIFONI DI  
SCARICO

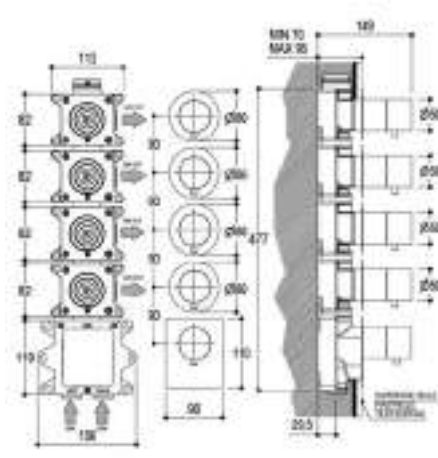

**Miscelatore termostatico ad incasso**  
 Built-in thermostatic mixer  
 UP-Thermostatmischer  
 Mitigeur thermostatique à encastrer  
 Mezclador termostático empotrado

**\_ regolatore di portata \_ filtri e valvole di non ritorno \_ quattro uscite indipendenti \_ completo di parti interne \_ installabile in posizione verticale oppure orizzontale**  
 \_ flow regulator \_ filters and non return valves \_ four separate exits \_ with inner parts \_ installation in both vertical and horizontal position  
 \_ Absperrung \_ Filter und Rückschlagventil \_ vier separate Abgänge \_ mit UP-Teilen \_ horizontal oder vertikal installierbar  
 \_ régulateur de débit \_ filtres et soupapes de non retour \_ quatre sorties indépendantes \_ avec parties internes \_ possible installation en vertical ou horizontal  
 \_ regulador de caudal \_ filtros y válvulas sin regreso \_ cuatro salidas independientes \_ completo de partes internas \_ instalación en posición horizontal o vertical

**IN** **OUT**  
 147 147



**Parti esterne**  
 Outer parts / Fertigset / Parties externes / Partes externas

**PR47HJ201**

**CRL**  
**IX, CRB, BLX**



**Parti da incasso**  
 Built-in parts / UP-teile / Parties internes / Partes internas

**PM0030M**



**Miscelatore completo**  
 Complete mixer / Vollständige Mischer / Mitigeur complete / Mezclador completo

**PR47HH201**

**CRL**  
**IX, CRB, BLX**

Accessori / Accessories / Zubehör / Accessoires / Accesorios

Ricambi / Spare parts / Ersatzteile / Pièces de rechange / Recambios



RCMB353  
 pag. 1219



RCMB828  
 pag. 1235



RCMB829  
 pag. 1235



RCMB833  
 pag. 1235



RCMB840  
 pag. 1235



RCMB996  
 pag. 1243



RCMBA012  
 pag. 1244

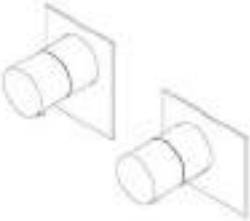
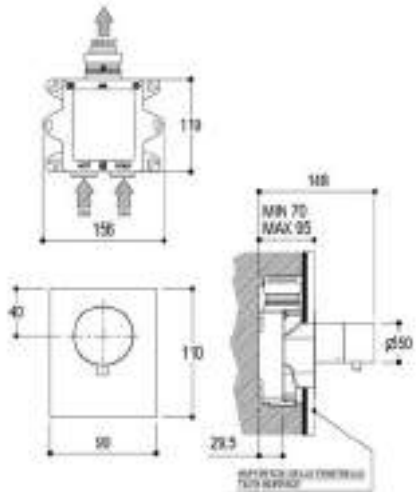

	<p><b>Miscelatore termostatico ad incasso</b>  <i>Built-in thermostatic mixer</i>  <i>UP-Thermostatmischer</i>  <i>Mitigeur thermostatique à encastrer</i>  <i>Mezclador termostático empotrado</i></p> <p><b>_piastra esterna _ regolazione di temperatura _ filtri e valvole di non ritorno _ una uscita _ completo di parti interne _ installabile in posizione verticale oppure orizzontale</b>  <i>_ external plate _ temperature regulation _ filters and non return valves _ one way _ with inner parts _ installation in both vertical and horizontal position</i>  <i>Montageplatte _ nur Temperaturregler _ Filter und Rückschlagventil _ Ein Abgang _ komplett mit UP-Teilen _ horizontal oder vertikal installierbar</i>  <i>_ plaque externe _ réglage de température _ filtres et soupapes de non retour _ one sortie _ avec parties internes _ possible installation en vertical ou horizontal</i>  <i>_ plancha externa _ regulación de temperatura _ filtros y válvulas sin regreso _ una salida _ completo de partes internas _ instalación en posición horizontal o vertical</i></p>	
<p>IN 1/4"</p> <p>OUT 1/4"</p>		

	<p><b>Parti esterne</b>  <i>Outer parts / Fertigset / Parties externes / Partes externas</i></p>	<p><b>PR47HC101</b> <b>CRL</b>  <b>IX, CRB, BLX</b></p>
---	--	---

	<p><b>Parti da incasso</b>  <i>Built-in parts / UP-teile / Parties internes / Partes internas</i></p>	<p><b>PM0030G</b></p>
--	---	-----------------------

<p><b>Miscelatore completo</b>  <i>Complete mixer / Vollständige Mischer / Mitigeur complete / Mezclador completo</i></p>	<p><b>PR47HB101</b> <b>CRL</b>  <b>IX, CRB, BLX</b></p>
---	---

Accessori / Accessories / Zubehör / Accessoires / Accesorios

Ricambi / Spare parts / Ersatzteile / Pièces de rechange / Recambios

 <p>RCMB828 pag. 1235</p>	 <p>RCMB833 pag. 1235</p>	 <p>RCMB840 pag. 1235</p>	 <p>RCMB996 pag. 1243</p>
--	--	--	--

**Per il corretto funzionamento l'articolo deve essere abbinato ad un rubinetto di arresto**  
*For proper working the item must be combined with a stop valve / Für den richtigen Betrieb muß der Artikel mit einem Unterputzabsperrventil kombiniert sein / Pour un fonctionnement correct l'article doit être jumelé avec un robinet d'arrêt / Para un funcionamiento correcto el artículo tiene que ser emparejado a una válvula de cierre*

POIS  
TIE  
TIP  
TAB  
REVERSO  
RITRÒ  
ELEMENTA IMPRONTA ACCESSORI  
ELEMENTA IMPRONTA ACCESSORI  
ACCESSORI  
COMPLEMENTI WC  
PILETTE  
SIFONI DI SCARICO

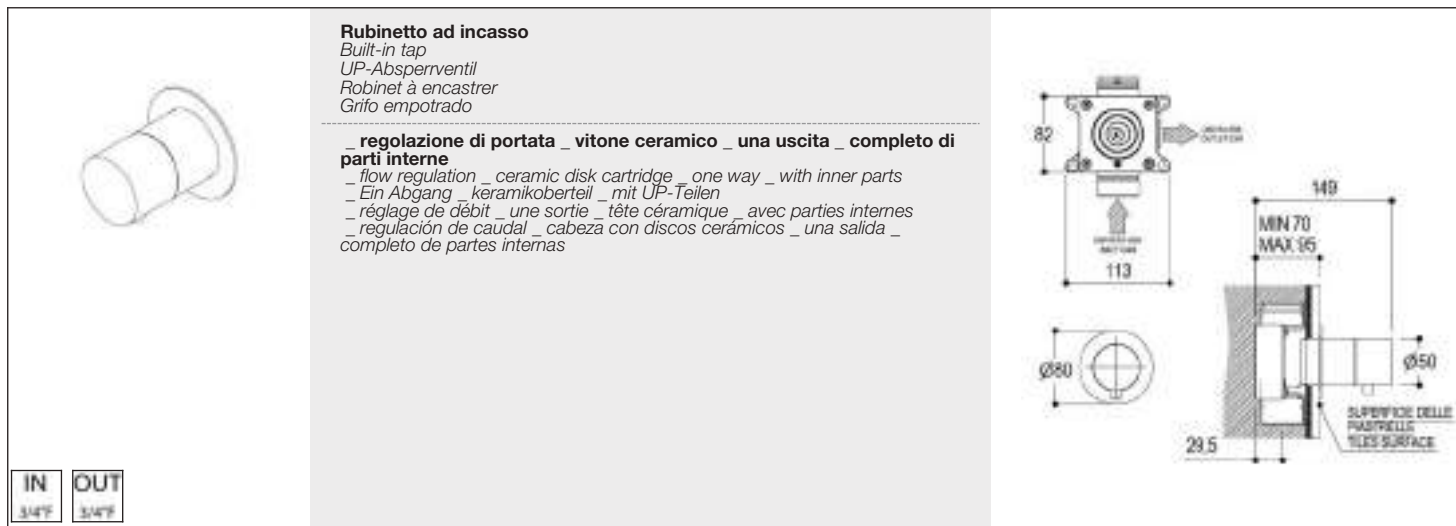

**Rubinetto ad incasso**  
 Built-in tap  
 UP-Absperrventil  
 Robinet à encastrer  
 Grifo empotrado

**\_ regolazione di portata \_ vitone ceramico \_ una uscita \_ completo di parti interne**  
 \_ flow regulation \_ ceramic disk cartridge \_ one way \_ with inner parts  
 \_ Ein Abgang \_ keramikoberteil \_ mit UP-Teilen  
 \_ réglage de débit \_ une sortie \_ tête céramique \_ avec parties internes  
 \_ regulación de caudal \_ cabeza con discos cerámicos \_ una salida \_ completo de partes internas

**IN** **OUT**  
 1/4" 1/4"

Technical drawing showing dimensions: 82, 113, 149, MIN 70, MAX 95, 29.5, Ø80, Ø50. Labels include 'SURFACE DELLE PASTIGLIE / TILES SURFACE'.



**Parti esterne**  
 Outer parts / Fertigset / Parties externes / Partes externas

**PR47JB201** **CRL**  
**IX, CRB, BLX**



**Parti da incasso**  
 Built-in parts / UP-teile / Parties internes / Partes internas

**PM00404** \_\_\_\_\_

**Miscelatore completo**  
 Complete mixer / Vollständige Mischer / Mitigeur complete / Mezclador completo

**PR47JA201** **CRL**  
**IX, CRB, BLX**

Accessori / Accessories / Zubehör / Accessoires / Accesorios

Ricambi / Spare parts / Ersatzteile / Pièces de rechange / Recambios

-   
 RCMB353  
 pag. 1219
-   
 RCMB829  
 pag. 1235
-   
 RCMA012  
 pag. 1244

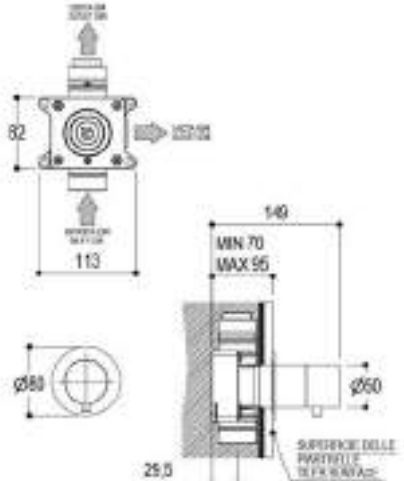
 <div data-bbox="199 549 309 604"> <p>IN 1/4" F OUT 2x 3/4" F</p> </div>	<p><b>Rubinetto di arresto anche per installazione in serie</b>  <i>Built-in stop valve connectable in series</i>  <i>UP-Absperrventil auch für Serieninstallation</i>  <i>Robinet d'arrêt a encastrer aussi pour l'installation en série</i>  <i>Valvula de cierre tambien para instalaciòn en serie</i></p> <hr/> <p><b>_ 1 ingresso _ 1 uscita laterale comandata da vitone ceramico con posizione di stop e regolazione di portata _ 1 uscita superiore sempre aperta per alimentazione in serie _ completo di parti interne</b>  <i>_ 1 inlet _ 1 lateral way controllable by ceramic headwork with stop position and flow regulator _ 1 upper way constantly open for connection in series _ with inner parts</i>  <i>_ 1 Zutritt _ 1 Seitenabgang bei einem Keramikoberteil bedient mit Stopposition und Durchflussmengeregelung _ 1 Obere Abgang immer geöffnet für Seriensorgung _ mit UP-Teilen</i>  <i>_ 1 entrée _ 1 sortie latérale commandée par une tête céramique avec position de stop et régulation du débit _ 1 sortie supérieure toujours ouverte pour alimentation en série _ complet de parties internes</i>  <i>_ 1 entrada _ 1 salida lateral mandada para una cabeza con discos cerámicos con posición de stop y regulador de caudal _ 1 salida superior siempre abierta para alimentación en serie _ completa de partes internas</i></p>	
---	--	---

	<p><b>Parti esterne</b>  <i>Outer parts / Fertigset / Parties externes / Partes externas</i></p>	<p><b>PR47JB201</b> <b>CRL</b>  <b>IX, CRB, BLX</b></p>
---	--	---

	<p><b>Parti da incasso</b>  <i>Built-in parts / UP-teile / Parties internes / Partes internas</i></p>	<p><b>PM00405</b></p>
--	---	-----------------------

<p><b>Miscelatore completo</b>  <i>Complete mixer / Vollständige Mischer / Mitigeur complete / Mezclador completo</i></p>	<p><b>PR47JA202</b> <b>CRL</b>  <b>IX, CRB, BLX</b></p>
---	---

Accessori / Accessories / Zubehör / Accessoires / Accesorios

Ricambi / Spare parts / Ersatzteile / Pièces de rechange / Recambios

 <p>RCMB353 pag. 1219</p>	 <p>RCMB829 pag. 1235</p>	 <p>RCMA012 pag. 1244</p>
--	--	--

POIS  
TIE  
TIP  
TAB  
REVERSO  
RITRÒ  
ELEMENTA ACCESSORI  
ELEMENTA IMPRONTE ACCESSORI  
ACCESSORI  
COMPLEMENTI WC  
PILETTE  
SIFONI DI SCARICO



**Deviatore ad incasso con regolazione portata**  
*Built-in diverter with flow regulator*  
*UP-Umstellung mit Absperrung*  
*Inverseur à encastrer avec régulateur de débit*  
*Desviador empotrado con regulador de potencia*

---

**\_ tre uscite: vasca-doccetta-soffione con posizioni di stop intermedie \_ completo di parti interne**  
*\_ three ways out: bath-hand shower-head shower with intermediate stop positions \_ with inner parts*  
*Dreiweg-Umsteller: Badewanne-Dusche-Kopfbrause mit Zwischenhaltpositionen \_ mit UP-Teilen*  
*\_ trois sorties: baignoire-douchette-tête de douche avec positions de stop intermédiaires \_ avec parties internes*  
*\_ tres salidas: bañera-ducha teléfono-rociador con posiciones de stop intermedias \_ completo de partes internas*

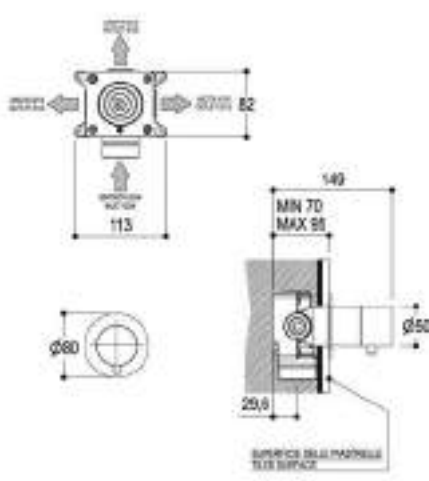

IN  
3/4"

OUT  
1/2"



**Parti esterne**  
*Outer parts / Fertigset / Parties externes / Partes externas*

**PR47LB201**

**CRL**  
**IX, CRB, BLX**

+



**Parti da incasso**  
*Built-in parts / UP-teile / Parties internes / Partes internas*

**PM00706**

=

**Miscelatore completo**  
*Complete mixer / Vollständige Mischer / Mitigeur complete / Mezclador completo*

**PR47LA201**

**CRL**  
**IX, CRB, BLX**

Accessori / Accessories / Zubehör / Accessoires / Accesorios

Ricambi / Spare parts / Ersatzteile / Pièces de rechange / Recambios

- 

RCMB829  
pag. 1235



RCMB909  
pag. 1240



RCMB954  
pag. 1241



RCMBA013  
pag. 1244

 <div style="display: flex; justify-content: space-around; margin-top: 10px;"> <div style="border: 1px solid black; padding: 2px;">IN 1/2"</div> <div style="border: 1px solid black; padding: 2px;">OUT 1/2"</div> </div>	<p><b>Deviatore ad incasso</b>  <i>Built-in diverter                  UP-Umstellung                  Inverseur à encastrer                  Desviador empotrado</i></p> <hr/> <p><b>tre uscite: vasca-doccetta-soffione e posizione di stop _ completo di parti interne</b>  <i>_ three ways: bath-hand shower-head shower and stop position _ with inner parts                  _ drei Abgänge: Wanne-Brause-Wandanschlußbogen und Stopstellung _ mit UP-Teilen                  _ trois sorties: baignoire-douchette-bras de douche et stop _ avec parties internes                  _ tres salidas: bañera-duchita-pomo ducha y stop _ completo de partes internas</i></p>	
---	---	---

	<p><b>Parti esterne</b>  <i>Outer parts / Fertigset / Parties externes / Partes externas</i></p>	<p><b>PR47LB221</b> <b>CRL</b>  <i>IX, CRB, BLX</i></p>
---	--	---

	<p><b>Parti da incasso</b>  <i>Built-in parts / UP-teile / Parties internes / Partes internas</i></p>	<p><b>PM00707</b></p>
--	---	-----------------------



<p><b>Miscelatore completo</b>  <i>Complete mixer / Vollständige Mischer / Mitigeur complete / Mezclador completo</i></p>	<p><b>PR47LA221</b> <b>CRL</b>  <i>IX, CRB, BLX</i></p>
---	---

Accessori / Accessories / Zubehör / Accessoires / Accesorios

Ricambi / Spare parts / Ersatzteile / Pièces de rechange / Recambios

				
RCMB199 pag. 1217	RCMB462H1 pag. 1220	RCMB898 pag. 1239	RCMB954 pag. 1241	RCMBA129 pag. 1248

POIS  
TIE  
TIP  
TAB  
REVERSO  
RITRÒ  
ELEMENTA ACCESSORI  
ELEMENTA IMPRONTE ACCESSORI  
ACCESSORI  
COMPLEMENTI WC  
PILETTE  
SIFONI DI SCARICO

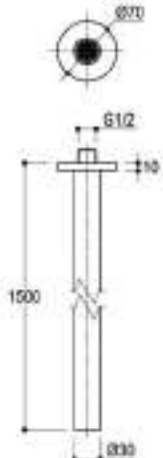
 <div data-bbox="88 549 204 604">  </div>	<p><b>Bocca di erogazione da soffitto per lavabo</b>  <i>Washbasin ceiling mounted spout</i>  <i>Waschbecken Deckenauslauf</i>  <i>Bec de lavabo suspendu</i>  <i>Caño salida a techo por lavabo</i></p> <hr/> <p><b>L=1500mm</b>          - L=1500mm          - L=1500mm          - L=1500mm          - L=1500mm</p>	
---	---	---

E0BA0185H03

CRL  
 IX, CRB, BLX

Accessori / Accessories / Zubehör / Accessoires / Accesorios

Ricambi / Spare parts / Ersatzteile / Pièces de rechange / Recambios



RCMB507  
 pag. 1221

 <div data-bbox="88 1415 204 1471">  </div>	<p><b>Bocca di erogazione da soffitto per lavabo</b>  <i>Washbasin ceiling mounted spout</i>  <i>Waschbecken Deckenauslauf</i>  <i>Bec de lavabo suspendu</i>  <i>Caño salida a techo por lavabo</i></p> <hr/> <p><b>Lunghezza (L) personalizzabile su richiesta: minimo 500mm, massimo 1600mm</b>          - Customizable length (L) on application, min 500mm max 1600mm          - Länge (L) auf Wunsch min 500mm max 1600mm          - Longueur (L) personnalisable sur demande min 500mm max 1600mm          - Largo (L) personalizable sobre solicitud min 500 max 1600mm</p>	
---	---	--

E0BA0185H--

CRL  
 IX, CRB, BLX

Accessori / Accessories / Zubehör / Accessoires / Accesorios

Ricambi / Spare parts / Ersatzteile / Pièces de rechange / Recambios



RCMB507  
 pag. 1221

**Bocca di erogazione da muro per vasca**  
*Wall spout for bathtub  
 Wandauslauf für Badewanne  
 Bec verseur à mur pour baignoire  
 Caño a muro para bañera*

**IN**  
 1/2" M

PR34CC201

CRL  
 IX, CRB, BLX

Accessori / Accessories / Zubehör / Accessoires / Accesorios

Ricambi / Spare parts / Ersatzteile / Pièces de rechange / Recambios

RCMB512 pag. 1221    RCMB522 pag. 1222    RCMB719 pag. 1230

**Miscelatore monocomando**  
*Single lever mixer  
 Einhandmischer  
 Mitigeur monocommande  
 Mezclador monomando*

**IN**    **OUT**

PR34AW201

CRL  
 IX, CRB, BLX

Accessori / Accessories / Zubehör / Accessoires / Accesorios

Ricambi / Spare parts / Ersatzteile / Pièces de rechange / Recambios

RCMB015 pag. 1213    RCMB021 pag. 1214    RCMB125 pag. 1217    RCMB585 pag. 1224    RCMB742 pag. 1231

POIS

TIE

TIP

TAB

REVERSO

RITRÒ

ELEMENTA ACCESSORI

ELEMENTA IMPRONTE ACCESSORI

ACCESSORI

COMPLEMENTI WC

PILETTE

SIFONI DI SCARICO

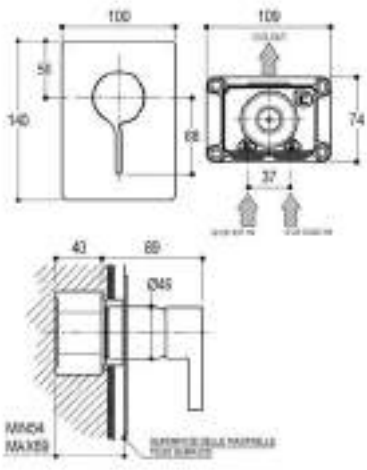
 <div data-bbox="95 549 204 606"> <p><b>IN</b> 1/2"</p> <p><b>OUT</b> 1/2"</p> </div>	<p><b>Miscelatore monocomando ad incasso per doccia/lavabo</b>  <i>Built-in single lever shower/basin mixer</i>  <i>UP-Einhandmischer für Dusche/Waschtisch</i>  <i>Mitigeur monocommande à encastrer pour douche/lavabo</i>  <i>Mezclador monomando empotrado para ducha/lavabo</i></p> <hr/> <p><b>_ piastra esterna _ una uscita _ completo di parti interne</b>  <i>_ external plate _ one way _ complete of inner parts</i>  <i>_ Montageplatte _ Ein Abgang _ komplett mit UP-Teilen</i>  <i>_ plaque externe _ une sortie _ complet avec parties internes</i>  <i>_ plancha externa _ una salida _ completo de partes internas</i></p>	
--	---	---

	<p><b>Parti esterne</b>  <i>Outer parts / Fertigset / Parties externes / Partes externas</i></p>	<p><b>PR34FC101</b></p>	<p><b>CRL</b>  <b>IX, CRB, BLX</b></p>
---	--	-------------------------	--



	<p><b>Parti da incasso</b>  <i>Built-in parts / UP-teile / Parties internes / Partes internas</i></p>	<p><b>E0BA0143</b></p>	
--	---	------------------------	--



<p><b>Miscelatore completo</b>  <i>Complete mixer / Vollständige Mischer / Mitigeur complete / Mezclador completo</i></p>	<p><b>PR34FB101</b></p> <p><b>CRL</b>  <b>IX, CRB, BLX</b></p>
---	--

Accessori / Accessories / Zubehör / Accessoires / Accesorios

Prolunghe / Extensions / Verlängerungen / Rallonges / Prolongadoras & Ricambi / Spare parts / Ersatzteile / Pièces de rechange / Recambios

<p><b>+20mm</b></p>	<p><b>+40mm</b></p>				
RCMB054H1 pag. 1202	RCMB054H2 pag. 1202	RCMB015 pag. 1213	RCMB508 pag. 1221	RCMB585 pag. 1224	RCMB742 pag. 1231



