

ARQUITECT

NOKEN CLEAN RIMLESS

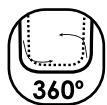

EFFICIENT FLUSH

This technology flushes all the inside of the toilet, enhancing the product's efficiency and getting to all corners.
Cette technologie rince tout l'intérieur de la cuvette en améliorant l'efficacité du produit pour arriver dans tous les coins.



EASY CLEAN

The elimination of the flange guarantees greater continuity of the surfaces inside the toilet, easing its cleaning and a lesser use of disinfectants.
L'élimination de la bride assure une meilleure continuité des surfaces de l'intérieur de la cuvette. Cela permet de faciliter le nettoyage tout en utilisant moins de désinfectants.



NO SPLASH

The accurate conduction of the water on the surfaces of the bowl of the toilet, with the right strength, confers an exceptional operation without splashing.
L'acheminement précis de l'eau sur les surfaces de la cuvette avec la force adaptée permet un fonctionnement exceptionnel et sans éclaboussures.



Noken CERAMIC

A special glaze that, thanks to ceramic firing at 1250 °C, makes it solid and unalterable. A totally hygienic barrier that creates a smooth surface.
Un émail spécial qui, grâce à la cuisson de la céramique à 1250 °, la rend solide et inaltérable. Une barrière totalement hygiénique qui crée une surface lisse.

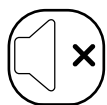

MORE SILENT

Thanks to its flushing system, it increases comfort as it significantly reduces the noise of flushing operations.
Grâce à son système d'évacuation, il améliore le confort du produit en réduisant considérablement le bruit de la chasse d'eau.

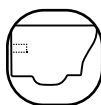

INVISIBLE FIXING

The innovative concealed fixing for suspended toilets by Noken gives the product greater visual cleanliness, allowing for easier installation and higher safety.
Grâce à la nouvelle fixation invisible sur les cuvettes suspendues de Noken, le produit procure une sensation de propreté, tout en étant plus facile à installer et plus sûr.



ARQUITECT

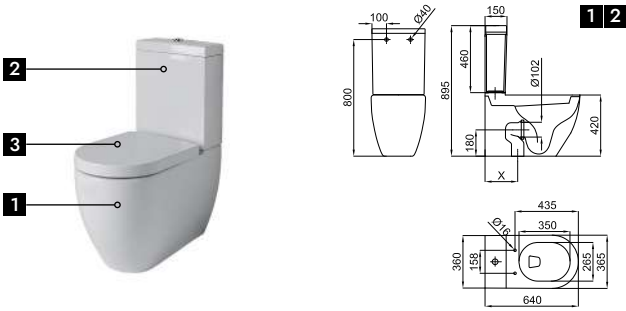

3A-3B

3C



1 C/C adjustable outlet "Rimless" pan with fixing kit 100041212.
Cuvette au sol "rimless" sortie orientable avec fixations 100041212.

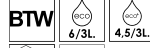

100278739

white
blanc



2A Cistern with inlet on upper left-hand side, pre-assembled mechanism, connections and seal. The water inlet can be mounted on the left or right. conventional flush 6 / 3 L.
Réservoir avec alimentation arrière supérieure à gauche. chasse conventionnelle - 6 / 3 L.



100048255

white
blanc



2B Cistern with inlet on upper left-hand side, pre-assembled mechanism, connections and seal. The water inlet can be mounted on the left or right. ECO flush 4,5 / 3 L.
Réservoir avec alimentation arrière supérieure à gauche. chasse ECO - 4,5 / 3 L.



100067646

white
blanc



2C C/C Cistern including internals bottom right inlet
Réservoir avec alimentation inférieure droite et mécanisme



100231506

white
blanc



3A Seat and cover
Abattant cuvette



100121996

white
blanc



3B Soft-close seat and cover
Abattant cuvette descente retenue

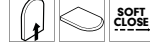

100122004

white
blanc



3C Soft-close seat and cover
Abattant cuvette descente retenue



100283411

white
blanc



It is required
Requiert

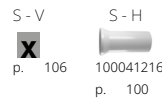

2C It is required
Requiert

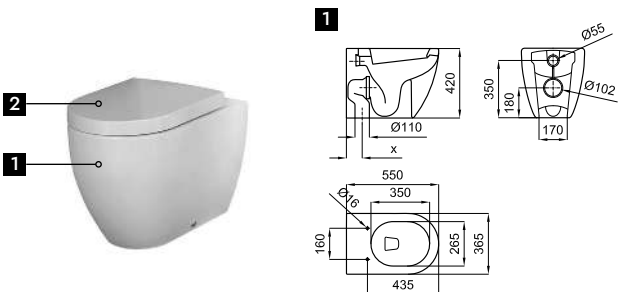

2A-2B

2C



1 "Rimless" back to wall pan. Adjustable outlet with fixing kit 100041212.
Cuvette indépendante "rimless" sortie orientable avec fixations 100041212.

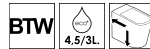

100278746

white
blanc



2A Seat and cover
Abattant cuvette



100121996

white
blanc



2B Soft-close seat and cover
Abattant cuvette descente retenue

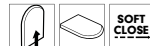

100122004

white
blanc



2C Soft-close seat and cover
Abattant cuvette descente retenue

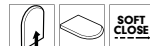

100283411

white
blanc



ARQUITECT

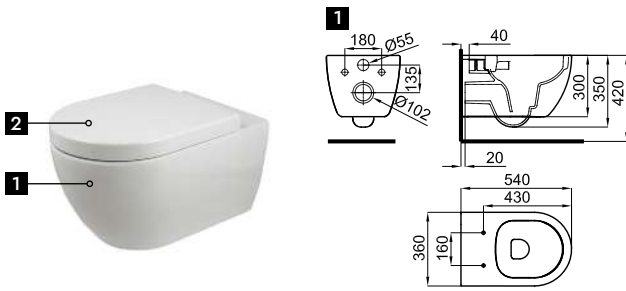

1 "Rimless" Wall hung pan. Includes the fixings kit.
Cuvette suspendue "rimless". Inclus fixations.

		clean rimless	100328472			
NEW						

2A Soft-close seat and cover
Abattant cuvette descente retenue

		SOFT CLOSE	100328604			
NEW						

2B Soft-close seat and cover
Abattant cuvette descente retenue

		SOFT CLOSE	100328614			
--	--	-------------------	------------------	--	--	--

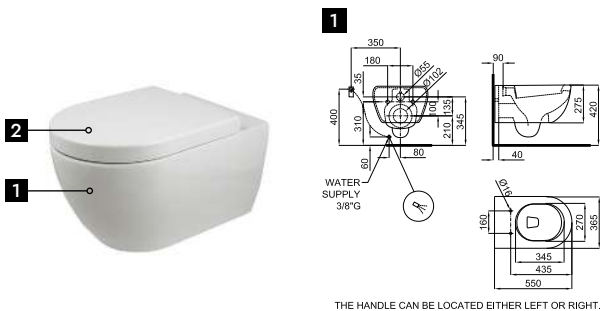

THE HANDLE CAN BE LOCATED EITHER LEFT OR RIGHT.

1 Wall hung pan with built-in bidet function and fixing kit 100253901
Cuvette suspendue et fonction bidet intégrée avec fixations 100253901

		100093383			
--	--	------------------	--	--	--

2A Seat and cover
Abattant cuvette

		100121996			
--	--	------------------	--	--	--

2B Soft-close seat and cover
Abattant cuvette descente retenue

		SOFT CLOSE	100122004			
--	--	-------------------	------------------	--	--	--

2C Soft-close seat and cover
Abattant cuvette descente retenue

		100283411			
--	--	------------------	--	--	--

For installation in wall frames/cisterns, check the maximum installation range of the pipes already included (drainage and supply) with the dimensions indicated in their respective drawings:
Drainage connection pipe: If a longer pipe length is required, up to a maximum installation range of 180 mm, please request the pipe corresponding to the code 100213056.
Supply pipe: If a longer pipe length is required, up to a maximum installation range of 120 mm, please request the pipe corresponding to the code 100213068.

Pour l'installation sur des châssis/citernes, vérifier la plage maximale d'installation des tubes déjà inclus (évacuation et alimentation) avec les cotes indiquées sur leurs plans respectifs :
Tuyau de raccordement de vidange : si vous avez besoin d'une longueur de tube supérieure, et pour une plage maximale d'installation de 180 mm, demandez le tube correspondant au code 100213056.
Tuyau d'alimentation : si vous avez besoin d'une longueur de tube supérieure, et pour une plage maximale d'installation de 120 mm, demandez le tube correspondant au code 100213068.

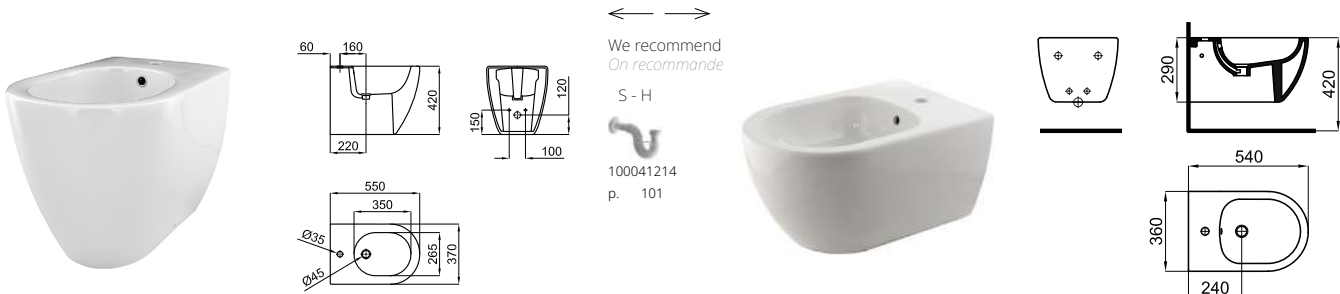

BTW		100048276			
------------	--	------------------	--	--	--

Bidet with fixing kit 100041212
Bidet avec fixations 100041212

		100328473			
NEW					

Wall hung bidet with fixing kit.
Bidet suspendu avec fixations.